

dS2832

User Manual Version 4.10

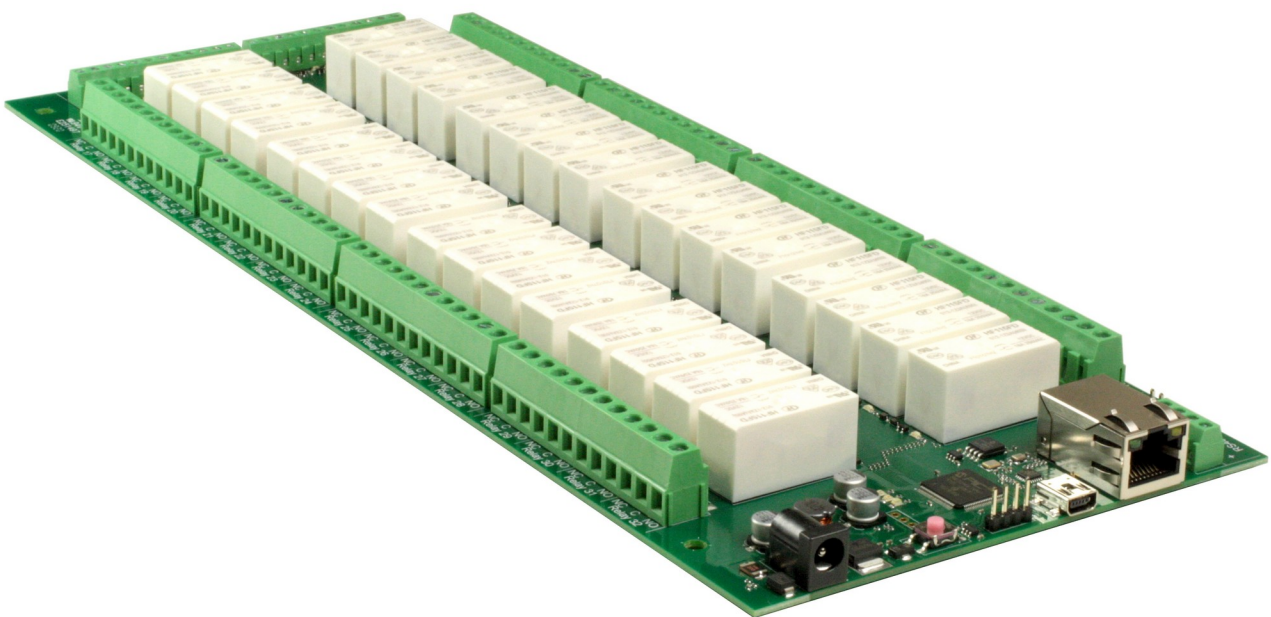

Table of Contents

Documentation history.....	3
A quick look.....	4
Introduction.....	5
Getting started.....	6
Locating the IP Address.....	7
Configuring the dS2832.....	9
Status page.....	10
Network page.....	11
Webpage security.....	12
TCP/IP page.....	14
Configuring relays.....	16
Relay automation.....	17
Input/Output configuration.....	20
Connecting I/O to Relays.....	21
dSx Configuration.....	22
dSx Mapping Table.....	23
dSx Example.....	25
Pinging remote machines.....	27
Repeat Time.....	27
Attempts.....	27
Delay.....	28
Ping Time.....	28
Rebooting the target machine.....	28
Email notifications.....	29
Peer to Peer.....	30
Sequencer.....	31
Sequencer commands.....	32
K Outputs.....	33
Sequencer Examples.....	33
Schedules.....	38
Counter/Timers.....	40
The application page.....	43
Application page security.....	44
Accessing your webpage from the internet.....	45
Boolean equations.....	46
TCP/IP command sets.....	48
ASCII command set.....	48
Binary command set.....	50
AES binary command set.....	53
Modbus commands.....	55
Function 01 (0x01) Read Coils.....	55
Function 04 (0x04) Read Input Registers.....	55
Function 05 (0x05) Write Single Coil.....	56
Function 15 (0x0F) Write Multiple Coils.....	56
Error code 1.....	56
Error code 2.....	56
Error code 3.....	56

Modbus Gateway.....	56
Loading the application firmware.....	57
Erasing old configuration settings.....	59
dS2832 hardware.....	60
LED indication.....	61
Power supply.....	61
Operating temperature.....	61
Power relays.....	62
Analogue/Digital flexible I/O's.....	63
Connection examples.....	63
Temperatue sensor.....	64
Power supply input voltage.....	64
Analogue channels.....	64
Serial port connections.....	66
dS2832 dimensions.....	67
Notes.....	68

Documentation history

V4.06	First release of the dS2832 manual.
V4.07	Added new features: Ping Used to ping other machines to check if responding. Sequencer Added a 120 step, 12 output sequencer
v4.08	Added display of MAC address to network configuration page. Bugfix – NTP (Real time clock) startup failed under some circumstances. Renamed command "counters" to "setcounters".
V4.09	Added 3 new commands to Binary and AES Binary command set, to control all relays in one command. Set all, set selected and clear selected.
V4.10	Added support for dSx42 extension modules.

Note: If you have a custom app based on app-dSxxxx-v4-07 or earlier, you will need to re-name the "counters" command to "setcounters" for it to compile with this version.

A quick look

Ethernet connected module, 10/100Mb auto negotiated.

Relays – 32 x 16Amp 250Vac C/O.

I/O – 8 x flexible I/O's NPN output, Volt free input or 12-bit analogue input.

Power – 12VDC 2Amp supply required. 2.1mm center positive.

Connections – Screw Terminals for N/O N/C and Common contacts

PCB size – 319mm x 123mm

Controlled graphically by secure webpage or optionally one of ASCII, Binary or Modbus command sets over TCP/IP.

Email notifications – 8 selectable notifications, up to 100 emails/hour max.

Peer to Peer – Control relays on other modules.

Line powered (up to 300 meter range) extension modules.

Sequencer – Flexible 100 step, 12 output sequencer

Schedules – Able to schedule events based on time of day/week

Counter/Timers – Count or time events. 10 counts/second Max.

Also available when optionally programming in dScript is a TTL level serial port and an RS485 serial port.

Introduction

The dS2832 is an Ethernet connected relay module featuring 32 channels of 16Amp 250Vac relays. Each relay has both normally open (NO) and normally closed (NC) as well as the common available on three terminals.

In addition to the relays, the dS2832 has 8 flexible I/O channels which may be individually configured to be:

1. NPN transistor output.
2. Active low input with pull-up (allows direct connection of volt free contacts).
3. Active low input without pull ups (easy to connect logic level inputs).
4. Analogue 12-bit inputs using a 4.096v reference (0v-4.096v input range).
5. Analogue 12-bit inputs using a 5v reference (0v-5v input range).

The dS2832 requires a 12v 2Amp power supply such as this one:

<http://www.robot-electronics.co.uk/universal-12vdc.html>

The dS2832 has four built in control methods.

Primary control method is graphically by using its built in secure website.

Secondary control may be one of:

ASCII - type in commands via a program such as PuTTY.

Binary - Command set using binary codes

Modbus – Functions 1, 4, 5 and 15 supported

And if you should wish to modify the supplied firmware – you can.

Behind the scenes there is dScript, a powerful multi-threaded operating system and programming language. The supplied firmware is written in dScript as well as HTML, CSS and Javascript on the webpages and the full source is in the separately down-loadable dScript support package.

You do not need to use dScript at all, but its great to know its there - just in case you do.

Getting started

Start by plugging in the Ethernet cable to connect the module to your network, and the 12v jack plug from your adapter. Switch on and the first thing you will note is that the blue LED will flash 3 times. This indicates that the control firmware is loaded on the module. *(If the blue led does not flash you will need to load in the control firmware. Don't worry, this is very easy to do. Just go to the chapter on installing the firmware and follow the instructions there).*

If you are using a Win7/8/10 PC, open your browser and into the address bar (not the search bar) type:

<http://dS2832/index.htm>

You should now see the application webpage and you can control relays and I/O's.

dScript

Relay 1	Relay 2	Relay 3	Relay 4
Relay 5	Relay 6	Relay 7	Relay 8
Relay 9	Relay 10	Relay 11	Relay 12
Relay 13	Relay 14	Relay 15	Relay 16
Relay 17	Relay 18	Relay 19	Relay 20
Relay 21	Relay 22	Relay 23	Relay 24
Relay 25	Relay 26	Relay 27	Relay 28
Relay 29	Relay 30	Relay 31	Relay 32

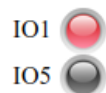

example.com	<input type="text" value="0"/>	Ctrl1	<input type="text" value="0"/>	<input type="text" value="0"/>
192.168.1.2	<input type="text" value="0"/>	Ctrl2	<input type="text" value="0"/>	<input type="text" value="0"/>
	<input type="text" value="0"/>	Ctrl3	<input type="text" value="0"/>	<input type="text" value="0"/>
	<input type="text" value="0"/>	Ctrl4	<input type="text" value="0"/>	<input type="text" value="0"/>

Locating the IP Address

If you are not using a windows PC then you will need to find the IP address of the module. The simplest method is connect the module (Ethernet, USB then lastly, Power) and load up the dScript editor.

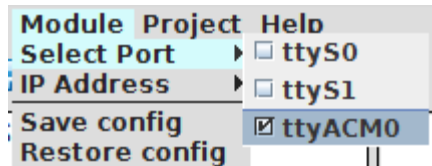

Go to Module→Select Port and make sure the correct serial port is selected as illustrated above.

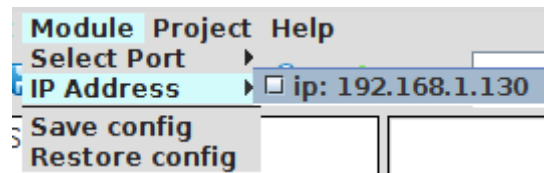

Now go to Module→ IP Address and the current IP address is displayed.

Make sure the Ethernet is connected before you apply power. If you plug the Ethernet cable in after the power, the module will already have booted with a default IP address.

Alternatively, if you have a DHCP server on your network (your router is normally the DHCP server) then the dS2832 will get its IP address from that. Log on to your router and navigate to the LAN client list.

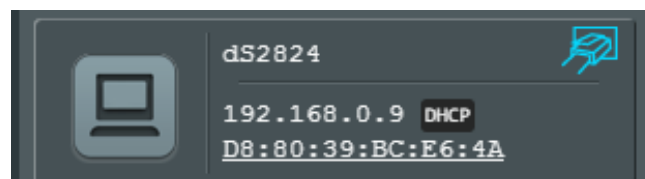

Above is the entry from our ASUS RT-N66U router. So now you type: 192.168.0.9/index.htm into your browser address bar and you should see the application webpage shown on the previous page.

If you prefer, you can download a java program that will run on Windows, MAC or Linux, and will list all of our modules that are connected to your LAN. [DevantechModuleFinder.jar](#)

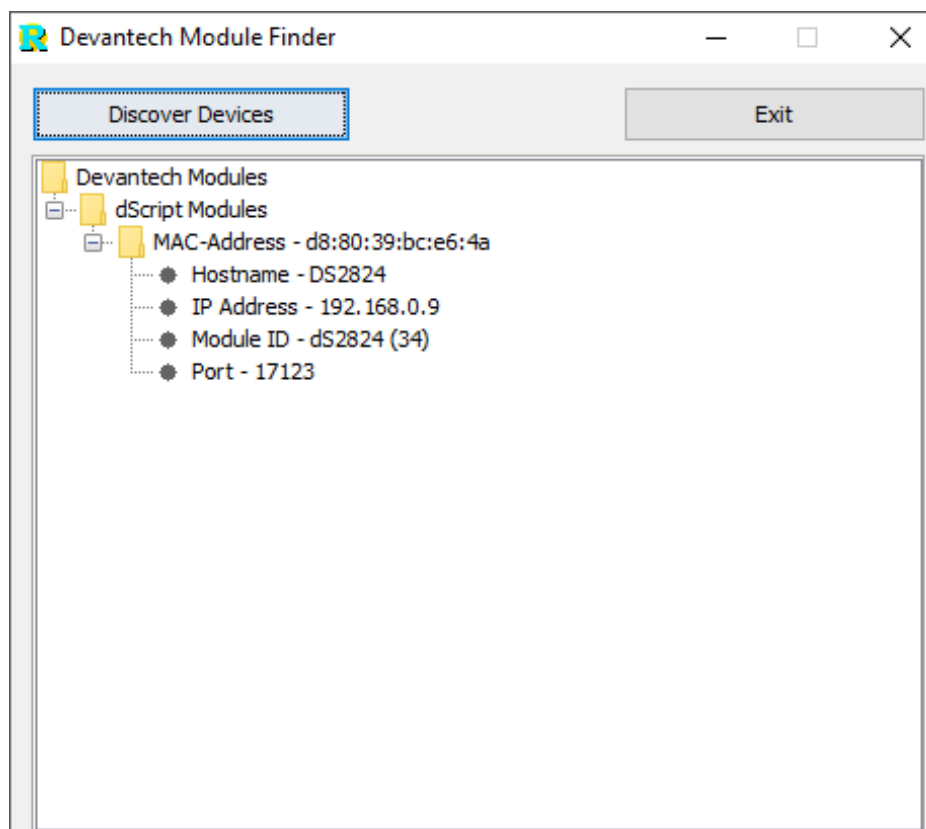

If you do not have a DHCP server the dS2832 will use a default IP address of 192.168.0.123 so make sure your PC is on the same subnet of 255.255.255.0 and its IP address is 192.168.0.xxx

Configuring the dS2832

There are a set of configuration pages to get the dS2832 operating as you want it. These pages are all `_configx.htm`, (that's a leading underscore character).
ie.

`_config.htm`
`_config2.htm`

Anything that starts with `_config` is considered a special name for configuration pages and can only be seen if you have the the USB cable plugged in and connected to your PC.

Why only if the USB cable is plugged in?

Its an additional security measure. After you have configured and deployed the module, you really don't want these configuration pages available for others to change. So with the USB cable disconnected the `_config` pages are not available. If you try to access them you just get served a "not authorised" page instead.

So for now, you do want to look over the config pages. If you have a Win10, Linux or MAC PC, you can go right ahead and plug in the USB cable. These machines will install their own USB drivers. We won't be sending anything to the board, its just the presence of the USB connection that enables the config pages to be served. If you have a Win7 or Win8 PC you will need to install the drivers. (*go to the chapter on installing the firmware and follow the instructions there*).

With the USB cable connected, browse to:
`192.168.0.9/_config.htm`
(substituting your IP address)

Status page

You should now see the following page:

Module	dS2832
System Firmware	4.10
Supplied Voltage	12.0 Vdc
Internal Temperature	27.3 °C

This status page shows you the system and application firmware revisions as well as the supplied voltage to the board and its internal temperature.

If you hover your mouse cursor over the menu buttons on the left, the help panel will give you an overview of each one.

The system reboot button should be used with caution. If the module is at a remote site and you change the IP address, you may not be able to reach it again.

Network page

The screenshot shows the 'System Configuration' page for the dS2832 device. On the left is a sidebar with buttons for 'Status', 'Network', 'TCP/IP', 'Relays', 'Input/Output', 'dSx Config', 'Ping', 'Email', 'Peer to Peer', 'Sequencer', 'Scheduler', 'Counter/Timer', and 'Application Page'. The 'Network' button is selected. The main configuration area is titled 'System Configuration' and includes the 'Devantech Ltd' logo. It displays the following settings:

- Host Name: dS2832
- IP Address: 192.168.0.123
- Subnet Mask: 255.255.255.0
- Gateway Address: 192.168.0.1
- Primary DNS: 192.168.0.1
- Secondary DNS: 8.8.8.8
- MAC Address: 04:91:62:70:BB:B1
- Enable DHCP:

Below these settings is the 'Webpage Security' section:

- Webpage Security: Configure the password for webpage security.
- Enable _pw.htm:
- Password: [Empty text field]
- HTTP Port: 80

At the bottom right, there is a red circular indicator with the text 'Update Pending'.

Notice that everything below the Host Name is greyed out and can't be changed. This is because the "Enable DHCP" box is checked and all the greyed out fields are supplied by the DHCP server. Although a quick way to get you connected, we really do not recommend this as the DHCP server can assign a different IP each time you power up. If you want to control this module from the internet while you are away from the premises then you will be setting up port forwarding on your router which requires a fixed IP address.

So lets do that first.

Uncheck the DHCP box and you can then set all the other fields. Notice that the Red "Update Pending" light comes on. It indicates there are changes which have not yet been written to the flash memory. It will go off again 5 seconds after you stop changing anything.

Choose an IP address for the module, something outside of the DHCP settings on your router so it will not assign anything to that address.

The subnet mask, Gateway and DNS can all be left as the defaults.

Network changes only take effect after the next re-boot, so wait until the "Update Pending" light goes out and give the reset button on the module a quick press. The Green Led will light and the Blue led will flash 3 times. You will now find the module at your new IP address. If the Red led comes on after you press the reset button, its because you pressed it for too long (and entered bootloader mode). Just have another go with the reset button for a bit less time.

Your browser won't know you have changed the IP address so it will still be showing the old, now dead page. Make sure you change to your new IP address and load the page again.

Webpage security

The webpage security section allows you to prevent unauthorised personnel from accessing the application webpage or using it to control the module.

Leaving the Security Password blank will disable it and allow everyone to access the application page to control the module.

To enable password protection enter a password into the Password box. You can use any characters from the ASCII character set from 0x20 to 0x7E except " (0x22). It may be up to 200 characters long and you don't have to memorise it, so make it a long one with plenty of upper-case, lowercase, numbers and symbols.

Accessing a special webpage, `_pw.htm`, will install the password on your browser. To do this make sure the Enable `_pw.htm` box is checked.

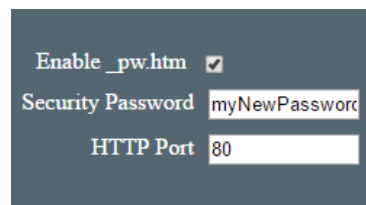

When the "Update Pending" light goes out, re-boot the module and go to yourIP/`_pw.htm`. You will see something like this:

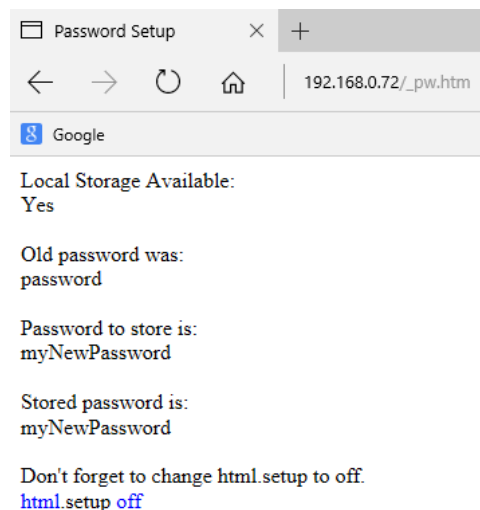

The password is now loaded on your browser. Do the same for any further browsers you want to enable. When you have done uncheck the "Enable _pw.htm" box to prevent anyone else from loading the password. When the "Update Pending" light goes out re-boot the module again.

The default port used by html webpages is 80. You can change this if required. If you do so then you will need to include the port number in the address.

If you change the port to 2345 then the webpage will be at:

YourIP:2345/index.htm

For example:

192.168.0.123:2345/index.htm

TCP/IP page

The TCP/IP tab allows you to select one of three command sets to control the module. These are independent of, and separate to the HTML webpage control.

The screenshot shows the 'System Configuration' interface for the dS2832 module. On the left is a vertical menu with buttons for: Status, Network, TCP/IP (selected), Relays, Input/Output, dSx Config, Ping, Email, Peer to Peer, Sequencer, Scheduler, Counter/Timer, and Application Page. The main area contains configuration options: ASCII (checked), ModBus, Binary, AES Binary, and Phone App (all unchecked). Below these are input fields for TCP/IP Port (17123), AES key (with a warning 'This MUST be 32 ch...'), and Password (123&Qx78). On the right, a 'TCP/IP' section contains the instruction: 'Choose the TCP/IP command set to use, or disable all check boxes for none.' At the bottom right, there is a circular 'Update Pending' indicator.

Clicking on one of the four check boxes will select that command set. Only one command set may be selected. You can disable all TCP/IP command sets by clicking on an already selected box.

The ASCII command set is text based. You can use any program that can send text over TCP/IP. We use PuTTY in raw mode. The Binary command set operates in a similar way to our ETHxxx range of boards (but uses different commands), by sending binary commands to the module. AES Binary adds encryption. Note the AES key MUST be 32 bytes long. We have test applications written in C# and Java to demonstrate AES encryption.

Phone App configures the module for control with our "IO network 2" app, available on iTunes/Play store. Password is an 8 character password used only with the App. Change this to a password of your choice and use the same password on your phone.

When selecting the Modbus commands, an additional set of configuration boxes are available.

dS2832 System Configuration Devantech Ltd

Status
Network
TCP/IP
Relays
Input/Output
dSx Config
Ping
Email
Peer to Peer
Sequencer
Scheduler
Counter/Timer
Application Page

ASCII
ModBus
Binary
AES Binary
Phone App
TCP/IP Port
AES key
Password
Modbus UID
Baudrate
Parity

TCP/IP
Choose the TCP/IP command set to use, or disable all check boxes for none.

Update Pending

These allow you to select the UID, normally you will leave this at the default of 1. The dS2832 will respond to commands on this UID. If you send any other UID it will be treated as the address of a Modbus module connected to the RS485 port. Commands to other UID's will be converted to Modbus RTU format and sent out on the RS485 port. Any responses will be converted back to Modbus/TCP format and returned to you.

The second box selects the baud rate of the Modbus RTU line and the third box selects even, odd or no parity.

The Modbus command set implements functions 1, 4, 5 and 15.

When selecting the Modbus command set, make sure you select port 502 which is the official port number for Modbus over TCP/IP.

A full description of the commands is in the "Command Sets" section later in this manual.

Important – If you want to use extension modbus modules over the RS485 bus, make sure the "Enable dSx" checkbox on the dSx Config page is unchecked, then reboot the module.

Configuring relays

The next two tabs allow you to set the names of the 32 relays that will be displayed on the application page.

The screenshot shows the 'dS2832 System Configuration' web interface. On the left is a sidebar with navigation buttons: Status, Network, TCP/IP, Relays (highlighted), Input/Output, dSx Config, Ping, Email, Peer to Peer, Sequencer, Scheduler, Counter/Timer, and Application Page. The main area is for configuring Relay No. 1. It includes a dropdown for 'Relay No.' set to 1, a text input for 'Relay Name' containing 'YardLights', and numeric inputs for 'Pulse/Follow' (0), 'Set Relay', 'Reset Relay', and 'Toggle Relay'. There is also a 'Power-up Restore' checkbox. On the right, a 'Relay Names' section explains that these are labels for relay buttons, with a maximum of 20 characters. An 'Update Pending' indicator is at the bottom right.

Use the Relay No. box to select the relay to configure. There are 32 relays available. Unlike other dS modules the dS2832 does not have virtual relays. All relays 1-32 are the physical relays, however I/O lines may still be linked to relays to provide additional physical outputs, see next section for details.

Names may be up to 20 characters long, but keep them shorter if you want to use a phone as the controller. Here we have renamed relay 1 as "YardLights" and those 10 characters are a comfortable size on a vertical phone screen.

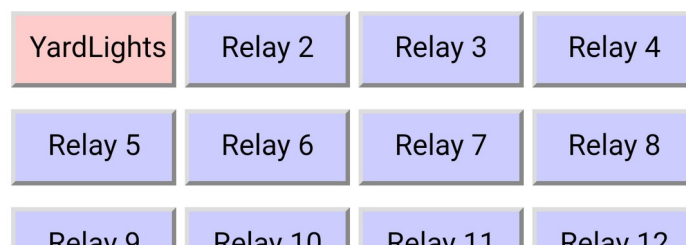

Relay automation

There are a set of control boxes that provide for autonomous relay operation. If you just want to control the relays from the webpage or using one of the TCP/IP modes, then leave these boxes blank.

Relay No. box

This selects the relay you wish to configure. On other dS modules this is to connect virtual relays to the I/O ports, however as the dS2832 has all 32 relay slots occupied there are no virtual relays. Relays can still be connected to an I/O port, but on the dS2832 it provides limited additional function.

Pulse/Follow box

If you place a number in this box then that is the pulse time for the relay in mS (1000mS = 1 second). The minimum value is 100mS. The maximum is 2147483647 (more than 24 days). When the relay is toggled on, timing begins and at the end of the time period the relay goes off again. If the button is pressed again during timing then the timing is restarted.



The screenshot shows a control panel for a relay. It includes a dropdown menu for 'Relay No.' set to '1', a text input for 'Relay Name' containing 'YardLights', a text input for 'Pulse/Follow' containing '1800000', and three buttons: 'Set Relay', 'Reset Relay', and 'Toggle Relay'. At the bottom, there is a 'Power-up Restore' checkbox which is currently unchecked.

The above example will turn off the yard lights after 30 minutes. 1800000 mS is 1800 seconds. 1800 seconds is 30 minutes.

It is also possible to insert a boolean equation into the box. Boolean equations are just simple equations that evaluate to a 0 or 1. For example Relay 1 is referred to as R1. Input1 is referred to as D1 (Digital 1). Analogue input 1 is referred to as A1.

Here's a very simple example:

Relay No.	1 ▾
Relay Name	YardLights
Pulse/Follow	R2
Set Relay	<input type="text"/>
Reset Relay	<input type="text"/>
Toggle Relay	<input type="text"/>
Power-up Restore	<input type="checkbox"/>

Enter R2 into the Relay 1 Pulse/Follow box. This will make relay 1 copy whatever you do to Relay 2. Try it!

Now change it to !R1.

Relay No.	1 ▾
Relay Name	YardLights
Pulse/Follow	!R2
Set Relay	<input type="text"/>
Reset Relay	<input type="text"/>
Toggle Relay	<input type="text"/>
Power-up Restore	<input type="checkbox"/>

The exclamation mark is read as "Not R1". Now relay 1 will always be the opposite of relay 2. Try it.

Boolean equations may be used for controlling relays and other objects such as email. See the "Boolean equation" section later in this manual for full documentation.

Set Reset & Toggle boxes

When used, these three controls contain boolean equations. The "Set Relay" box will set the relay when the boolean equation becomes true. The other two boxes reset and toggle the relay when the boolean equation become true.

This is important! The Set, Reset and Toggle controls are transitory (edge triggered) controls.

The relays are only affected at the moment the boolean equation becomes true. This differs from the Follow box where the relay continuously follows the output state of the equation.

In the previous example where we placed R2 in relay 1's Follow control, relay one will always be the same as relay 2. If relay 2 is off and we click relay 1 (YardLights) nothing will happen.

However if we want relay1 to be controlled by relay 2 as above, and also want to be able to toggle it on/off from the webpage, we can put R2 in the "Set Relay" box and !R2 in the "Reset Relay" box.

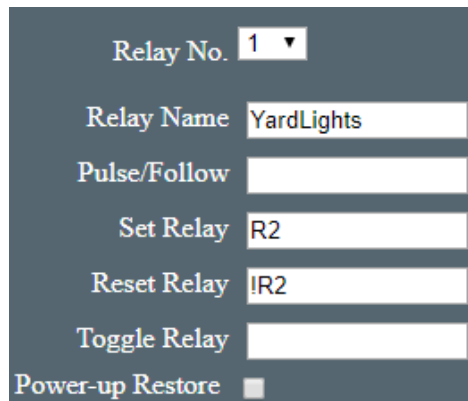

Relay No.	1 ▼
Relay Name	YardLights
Pulse/Follow	
Set Relay	R2
Reset Relay	!R2
Toggle Relay	
Power-up Restore	<input type="checkbox"/>

Try it.

Power-up restore

When checked, the relay is restored to the previous state it had when power was lost. If the relay was on when power was lost or the module was turned off, then the relay will be turned on when the module is powered up again.

Input/Output configuration

The I/O Names tab is used to assign meaningful names to the I/O terminals.

I/O	Name	Type	Mode
I/O 1	iO1	Digital With Pullup	None
I/O 2	iO2	Digital With Pullup	None
I/O 3	iO3	Digital With Pullup	None
I/O 4	iO4	Digital With Pullup	None
I/O 5	iO5	Digital With Pullup	None
I/O 6	iO6	Digital With Pullup	None
I/O 7	iO7	Digital With Pullup	None
I/O 8	iO8	Digital With Pullup	None

I/O Configuration

Names.
These are the I/O labels on the application page to give each I/O a unique and descriptive name. Maximum 20 characters.

Types.
Configure Digital I/O with or without pull-up resistors, or analogue inputs with 0-3.3v input.

Note, changes do not take effect until after the next re-boot.

Update Pending

As with relay names these may be up to 20 characters long, but do check it looks ok on a mobile device or whatever you are using to control the module.

Click on the drop down box selection tab to select the I/O type.

The two digital modes are the same except for "Digital No-Pullup" the passive pull-up resistor is turned off and for "Digital With Pullup" it is turned on.

The no-pullup option is useful for connecting to digital circuits (3.3v or 5v) that supply the input voltage. The with pullup option turns on a weak pull up to 12v (actually nearer 7-8v because of the input design). This is useful for directly connecting volt free contacts such as relay contacts or switches. They are connected between the pin (P) and ground (0v).

To use as inputs, make sure the output drive is off or the NPN transistor will drive the output low. The NPN transistor can sink about 100mA.

The analogue modes convert the input volts to a digital number in the range 0-4095 (12-bit conversion). The input voltage range is selectable for 4.096v (Analog Ref4) and 5v (Analog Ref5).

Connecting I/O to Relays

I/O 1	<input type="text" value="I01"/>	Digital With Pullup ▾	<input type="text" value="25"/> ▾
I/O 2	<input type="text" value="I02"/>	Digital With Pullup ▾	None ▾
I/O 3	<input type="text" value="I03"/>	Digital With Pullup ▾	None ▾
I/O 4	<input type="text" value="I04"/>	Digital With Pullup ▾	None ▾

Any of the eight digital I/O lines may be connected to a relay. This gives the digital output the same automation capabilities as the relays. Enter the relay number in the link box as shown above. Any relay may be selected for an I/O.

When you have configured the I/O, wait for the "Update Pending" light to go out and press the reset button, as new I/O modes are set on power-up.

dSx Configuration

Used to configure dSx42 modules connected to the RS485 bus.

dSx42 modules are extension I/O modules that are connected to the RS485 bus (serial port 3). Up to 16 dSx modules may be added, controlled by the dS2832 as if they are local I/O. The outputs are mapped to 2 of the 32 relays – real or virtual and the inputs can be accessed in the range 100-163. dSx modules are powered from the 12v output on the dS2832's RS485 connector and wired using a separate pair in the cable. A 2 pair cable is therefore required. The dSx modules use very little current (less than 7mA each) and 15 of them are easily powered at the far end of 100 meters of cheap cable. Maximum distance is 305 meters (1000 ft).

Configuration

dS2832 System Configuration Devantech Ltd

Status
Network
TCP/IP
Relays
Input/Output
dSx Config
Ping
Email
Peer to Peer
Sequencer
Scheduler
Counter/Timer
Application Page

Enable dSx

dSx Search

UID	Map	UID	Map
635C8A	25	635C8C	27
635C8D	29	635C8E	31
635C8F	23	0	-
0	-	0	-
0	-	0	-
0	-	0	-
0	-	0	-
0	-	0	-
0	-	0	-

[dSx42 Overview](#)

dSx Extension Modules.
Configure dSx I/O extension modules that are connected down stream on the RS485 port.

dSx mode is enable by checking the Enable dSx box. This will configure serial port 3, the RS485 port, to 250k baud as used by the dSx modules. If un-checked the port will be configured to the Modbus settings on the TCP/IP page. Reset the board after checking or un-checking this box.

To automatically search for dSx modules on the RS485 bus click the Start button. This will clear all previous devices and mappings and fill the list with all devices found and offer a default mapping.

The UID buttons will have the UID's found, listed in ascending order (not the physical position on the bus). If you need to identify which module assigned to that UID, click the button and all LEDs on the module will flash. Only one module will be in identify mode at any time. If you click another button, then that modules LEDs will flash and the first module will stop. Click the button again, or click an empty (0) button to stop the flashing and clear identify mode.

Note that normal operation of the dSx modules is inhibited in identify mode.

Mapping the dSx modules.

Each dSx module has 2 outputs and 4 inputs. The 2 relays may be mapped onto any of the 32 relays (real or virtual). Mapping a module to position 5 means that relays 1 and 2 on the dSx module will be controlled by virtual relays 5 and 6 on the dS2832. The mapping can be changed by selecting a new mapping with the drop-down box.

dSx Mapping Table

Mapping	Relay 1	Relay 2	Input 2	Input 2	Input 3	Input 4
1	1	2	100*	101*	102	103
3	3	4	104	105	106	107
5	5	6	108	109	110	111
7	7	8	112	113	114	115
9	9	10	116	117	118	119
11	11	12	120	121	122	123
13	13	14	124	125	126	127
15	15	16	128	129	130	131
17	17	18	132	133	134	135
19	19	20	136	137	138	139
21	21	22	140	141	142	143
23	23	24	144	145	146	147
25	25	26	148	149	150	151
27	27	28	152	153	154	155
29	29	30	156	157	158	159
31	31	32	160	161	162	163

* Note that inputs 100 and 101 are not available, either as analogue or digital inputs. If you need to use all inputs on the dSx module, map it something other than 1.

This is because A100 and A101 are historically used for the on-board temperature and DC voltage inputs.

dSx42

Relay 3, Relay 4	Relay 5, Relay 6	Relay 7, Relay 8
Relay 9, Relay 10	Relay 11, Relay 12	Relay 13, Relay 14
Relay 15, Relay 16	Relay 17, Relay 18	Relay 19, Relay 20
Relay 21, Relay 22	Inputs 144-147 635C8F Relay 23, Relay 24 0, 0, 373, 378	Inputs 148-151 635C8A Relay 25, Relay 26 0, 0, 0, 0
Inputs 152-155 635C8C Relay 27, Relay 28 0, 341, 0, 0	Inputs 156-159 635C8D Relay 29, Relay 30 0, 0, 0, 0	Inputs 160-163 635C8E Relay 31, Relay 32 1023, 1023, 1023, 1023

Note: Position 1 not shown, positions 2-16 displayed.

Clicking the “dSx42 Overview” link will take to to a test page where you can view the selected mapping by position.

Mapped dSx42 modules are shown with a magenta outline. The input range for that module and its UID is displayed. The inputs received from the dSx42 are shown as an analogue value. Digital inputs are displayed as zero or 1023 (or close to that).

The relay buttons will toggle the relays, even where no dSx42 is present, because they are the hosts virtual relays.

Position 1 is not shown because all dScript modules have relays there and inputs 100 & 101 are not available so you will probably not use that position, but you can if you need to.

dSx Example

As an example, let's assume the following:

You need 2 dSx42 relay modules. You want relay 1 on one module to be controlled by input 2 from the other module using its analogue input.

The dSx analogue inputs are 0-5v and use 10-bit conversion, which is a range of 0-1023.

You want the relay to turn on when the input goes below 511 (about 2.5v) and off above that value.

First connect your 2 dSx42 modules to the RS485 port and click "Start". You should see the two UID's for your boards listed.

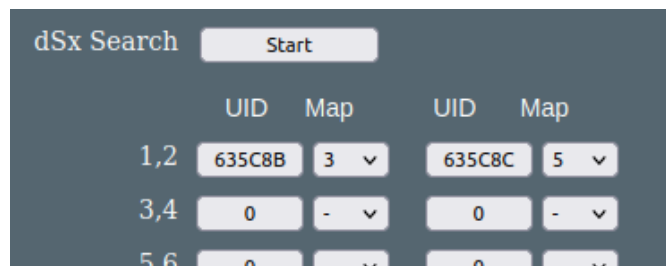

Next change the mapping as required to 29 for the first module and 31 for the other, using the drop-down selection boxes.

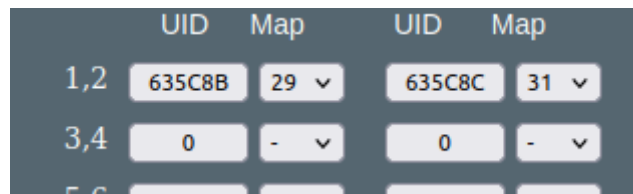

Note: the UID's are presented in ascending order, not any physical position on the RS485 bus, so you will likely need to confirm which UID belongs to which module. Clicking the UID button makes that module identify itself by flashing all its LEDs. Click again to stop.

If you find it's the module mapped to 29 that has the analogue input wired to it, swap them over by changing the mapping like this:

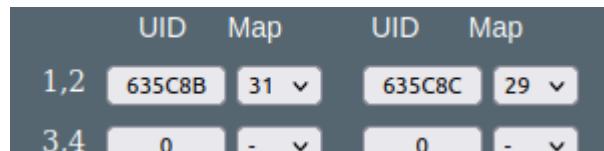

You should always design your system by mapping number, not UID. That way if you ever need to change a module you just make sure it has the same mapping as the original and your all good to go. As part of your system documentation, record the mapping number against module task so you can quickly restore the system should you need to.

So now the relay we wish to control is mapped to virtual relay 29 and the input that is going to control it is mapped to input 161, which is the 2nd input on mapping 31. The input number was obtained from the table on a previous page.

Now we can go to the Relays page and configure the relay. Select relay 29 from the drop-down box.

The screenshot shows a web interface for configuring a relay. On the left, there is a vertical menu with buttons for 'Status', 'Network', 'TCP/IP', 'Relays', 'Input/Output', and 'dSx Config'. The 'Relays' button is highlighted. The main content area is titled 'Relay No. 29' with a dropdown arrow. Below this, there are several input fields: 'Relay Name' with the text 'Relay 29', 'Pulse/Follow' with the value '0', 'Set Relay', 'Reset Relay', 'Toggle Relay', and 'Power-up'.

If you want, you can give the relay a more descriptive name. To use input 161 as an analogue input we use A161. If we wanted a digital input it would be D161. Enter the following into the Pulse/Follow box:

A161<511

All other fields can remain empty.

This is a close-up of the configuration form. The 'Relay No.' dropdown is set to '29'. The 'Relay Name' field contains the text 'Tank 3 Heater'. The 'Pulse/Follow' field contains the text 'A161<511'. The 'Set Relay' field is empty.

Now the relay will turn on when the input is less that 511.

Although A161<511 is simple to understand, its not actually the best way to do it. Analogue inputs by their nature can jitter around. This can cause the relay to pulse on/off as the input jitters close to 511. A better way is to include some hysteresis like this:

`(A161<509&!R29)|(A161<513&R29)`

This means the relay will turn on when the input is below 509 (508 or less), but will not turn off again until the input is above 512 (513 or more). The greater the difference between the two numbers, the greater the hysteresis.

Pinging remote machines

The screenshot shows the 'dS2832 System Configuration' interface. On the left is a sidebar with buttons for various settings: Status, Network, TCP/IP, Relays, Input/Output, dSx Config, Ping (highlighted), Email, Peer to Peer, Sequencer, Scheduler, Counter/Timer, and Application Page. The main configuration area is divided into two sections for ping settings. The top section has 'Ping No.' set to '1,2', 'Remote Host' as 'example.com', 'Repeat Time' as '0', 'Attempts' as '3', 'Delay' as '600', and 'Time uS' as '0'. The bottom section has 'Remote Host' as '192.168.1.2', 'Repeat Time' as '0', 'Attempts' as '3', 'Delay' as '600', and 'Time uS' as '0'. To the right of these settings is a 'Ping' help box with the text: 'Ping to up to four remote hosts. Used to test if a remote system is alive and responding.' At the bottom right of the interface, there is a circular indicator and the text 'Update Pending'.

The ping module allows you to check other machines are still online and responding.

Ping threads are only started a boot time if the Repeat Time is greater than zero. Also DNS lookup is only performed once at boot time if the Repeat Time is greater than zero. So after making changes, wait for the Update Pending light to go out (5 seconds after last change) and reboot the module.

Repeat Time

This is how often the ping is repeated, in seconds. 10 sends a ping every 10 seconds.

Attempts

The number of failed pings (no response) before failure is reported by setting the ping time to zero. If set to 5 it will take 5 consecutive failed responses to trigger a failure. If a response is received, say on the 3rd try, the attempt counter is reset to 5.

Delay

This is the delay between detecting the failed responses and re-starting the pings. It is also the startup delay before beginning pings. Its purpose is to give the target machine time to boot up, or reboot.

Ping Time

The time between sending the ping message and receiving the response. Timing is given in μ S, but subject to a 1-2mS jitter.

Rebooting the target machine

A relay can be used to reboot the target machine. This may be by connecting to its reset input, or even removing and restoring power. The details of this are left to you.

In this example we are going to generate a reset pulse by pulsing Relay1 for 2 seconds when the ping time goes to zero. To do this enter 2000 in the pulse/follow box and P1<1 in the Set Relay box.

Relay Name	Relay 1
Pulse/Follow	2000
Set Relay	P1<1
Reset Relay	
Toggle Relay	
Power-up Restore	<input type="checkbox"/>

If you are going to reboot by removing power, you might want a longer pulse, say 30000mS or 30 seconds.

You might also send a notification email:

From Address	noreply@dscript-mail.uk
Email No.	1
Email Address	yourname@example.com
Subject	Machine 1 failed
Trigger	P1<1

Email notifications

The final configuration tab is the Email tab for sending secure, AES encrypted email notifications from the module.

The screenshot shows the 'dS2832 System Configuration' web interface. The top left corner displays the 'dS2832' logo and 'System Configuration'. The top right corner shows 'Devantech Ltd'. On the left side, there is a vertical sidebar with buttons for: Status, Network, TCP/IP, Relays, Input/Output, dSx Config, Ping, Email (highlighted), Peer to Peer, Sequencer, Scheduler, Counter/Timer, and Application Page. The main configuration area contains the following fields:

- From Address:
- Email No.:
- Email Address:
- Subject:
- Trigger:

On the right side, there is a 'Easy Mail' section with the text: 'Send secure emails in response to selected events.' At the bottom right, there is a circular 'Update Pending' indicator.

Up to eight (8) email notifications may be set up, selected with the Email No. box.

Setting up emails is quick and easy. You just need the recipients email address, a notification message which will be the email subject line and the trigger event.

The trigger event uses the same boolean equation solver as the relay automation. So if you want to trigger an email when digital input 1 (I/O1) becomes active, just enter D1.

The email message is automatically filled in with useful information on the state of the relays, I/O's etc.

Boolean equations are used for controlling relays as well as triggering email notifications.

See the "Boolean equation" section later in this manual for full documentation.

Note - Email notifications are limited to 100/hour.

Peer to Peer

This tab allows you to configure events on this module to control relays on another.

dS2832 System Configuration Devantech Ltd

P2P No.

Input

Target IP

Target Port

Target Relay No.

Target Action.

TCP/IP Timeout.

Use AES

Peer to Peer

Use inputs on this module to control relays on other dSxxx modules which can be on your local LAN or across the internet.

Up to eight (8) Peer to Peer events may be set up, selected with the P2P No. box.

Control of the target relay is by using the binary command set only. This can optionally use AES encryption. The Target module must be set to either Binary or AES Binary mode on its TCP/IP tab, and this "Use AES" checkbox set to match.

The input box selects the event that will be used to control the target relay. This can be as simple as an input, or a complex Boolean equation. See the "Boolean equation" section later in this manual for full documentation.

Target IP, Port & Relay No should be set to locate the target relay.

Target action determines how the relay will be controlled.

0 - No action, this Peer to Peer event is disabled.

1 - Follow Me, the relay will follow the input, (or the Boolean result of any equation here).

2 - Set Relay, the relay will be set by this event. You will need another P2P event to reset it.

3 - Reset Relay, the relay will be reset by this event. You will need another P2P event to set it.

4 - Toggle Relay, this will toggle the relay each time the event is triggered.

20+ - Pulse relay, Pulse times are in mS. (1000mS=1Second).

5-19 will have no action.

Sequencer

The sequencer runs a continuous loop of up to 120 steps. At each step you can specify a time delay and the outputs. The K1 – K12 outputs are updated and the start of the delay time. The example above shows the simplest sequence possible. At line 01 it delays 1 second and turns on the K1 output. Line 02 delays 1 second and turns off the K1 output. Line 03 jumps back to line 1 and the cycle repeats forever.

The K1 – K12 outputs may be used in boolean equations to control relays, send emails, etc.

Relay Name	Relay 1
Pulse/Follow	K1
Set Relay	
Reset Relay	
Toggle Relay	
Power-up Restore	<input type="checkbox"/>

Placing K1 in a relays Pulse/Follow box will make the relay follow the K1 output, in this case pulsing the relay on and off every two seconds.

Sequencer commands

There are a set of 12 commands to control the sequencer.

The simplest of these is just a number which is the time delay in seconds.

1234	Numbers may be up 4093 seconds.
m500	This is the time delay in mS. There is a limit of Max. 4093ms.
M10	The time delay in minutes. There is a limit of Max. 4093 minutes.
H2	The delay in hours. There is a limit of Max. 596 hours.
U90	Unspecified delay in seconds. Its a random number up to the limit specified. The Max. delay that may be specified is 4093 seconds.
T16:45	Waits until the specified time before continuing. Make sure you have an internet connection and the clock is correctly set up on the Scheduler page.

At the start of all the delay commands above, the K outputs will be updated with the specified settings, then after the delay time, the sequencer moves on to the next line.

None of the following commands will update the K outputs. If you specify anything in these check boxes they will be ignored. The instructions are executed immediately with no delays.

J1	Jumps to the specified line.
C9	Calls the specified line. The sequencer has a 4 deep call/return stack. The line following this one is pushed onto the stack and control transferred to the specified line.
X	eXit. Returns from a previous call. The line that was pushed onto the stack from the last call is popped off and control transferred to that line. There are no parameters to this command.

The following conditional jump commands take two parameters, the object number and the line to jump to. They will jump to the specified line if the object is active (on), otherwise continues with the next line. They do not stop and wait.

R1, 12	Tests R1 (Relay 1) and jumps to line 12 if active (on).
D1, 20	Tests D1 (Digital Input 1) and jumps to line 20 if active.
S1, 30	Tests S1 (Schedule 1) and jumps to line 30 if active.

K Outputs

The sequencer outputs are a set of 12 flags, K1 to K12. These may be used anywhere a boolean is used, to control relays etc.

For simple sequences the K output can be used in the Relays pulse/Follow box.

More complex sequences using call/return instructions should use the K flags in the Set, Reset and Toggle boxes. Then use one K flag to set the relay and another to reset it. The K flags are now only be needed at the point you need to switch the relay. In this way a common called sequence will only affect the specified relays, not everything.

Sequencer Examples

Scanning inputs, waiting for something to do.

Supposing you need to monitor two inputs and perform one of two control sequences depending on the input. We will need a loop to check the inputs and transfer to the appropriate sequence when active.

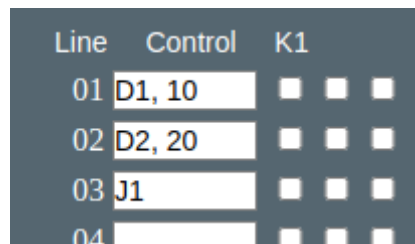

Line	Control	K1
01	D1, 10	
02	D2, 20	
03	J1	
04		

If D1 becomes active control transfers to line 10.

If D2 becomes active control transfers to line 20.

Otherwise they arrive at line 3 and jump back to line 1.

The sequence will loop around these three lines until one of the digital inputs becomes active.

At the end of the routines at lines 10 and 20 you should finish with jumps back to line 1.

Traffic Lights

Here in the UK the traffic light sequence is Red, Red + Amber, Green, Amber, Red. You would need more than two relays for this, but we can watch the sequence on the virtual relays on the application page. Here is a sequence for a 2-way traffic control of the type you normally see at road works.

Line	Control	K1			K6	K7
01	30	<input checked="" type="checkbox"/>	<input type="checkbox"/>	<input type="checkbox"/>	<input checked="" type="checkbox"/>	<input type="checkbox"/>
02	2	<input checked="" type="checkbox"/>	<input checked="" type="checkbox"/>	<input type="checkbox"/>	<input checked="" type="checkbox"/>	<input type="checkbox"/>
03	60	<input type="checkbox"/>	<input type="checkbox"/>	<input checked="" type="checkbox"/>	<input checked="" type="checkbox"/>	<input type="checkbox"/>
04	3	<input type="checkbox"/>	<input checked="" type="checkbox"/>	<input type="checkbox"/>	<input checked="" type="checkbox"/>	<input type="checkbox"/>
05	30	<input checked="" type="checkbox"/>	<input type="checkbox"/>	<input type="checkbox"/>	<input checked="" type="checkbox"/>	<input type="checkbox"/>
06	2	<input checked="" type="checkbox"/>	<input type="checkbox"/>	<input type="checkbox"/>	<input checked="" type="checkbox"/>	<input checked="" type="checkbox"/>
07	60	<input checked="" type="checkbox"/>	<input type="checkbox"/>	<input type="checkbox"/>	<input type="checkbox"/>	<input checked="" type="checkbox"/>
08	3	<input checked="" type="checkbox"/>	<input type="checkbox"/>	<input type="checkbox"/>	<input checked="" type="checkbox"/>	<input type="checkbox"/>
09	J1	<input type="checkbox"/>	<input type="checkbox"/>	<input type="checkbox"/>	<input type="checkbox"/>	<input type="checkbox"/>
10		<input type="checkbox"/>	<input type="checkbox"/>	<input type="checkbox"/>	<input type="checkbox"/>	<input type="checkbox"/>

Here we hold both lights at Red for 30 seconds to give traffic time to traverse the controlled area. Then Red + Amber for two seconds followed by Green for 60 seconds. We then stop the traffic with Amber for 3 seconds followed by Red. Again we hold both lights at Red for 30 seconds before letting the other queue through at line 6.

To watch it happen, set relays 21, 25 & 29 to K1, K2 & K3 and set relays 24, 28 & 32 to K4, K5 & K6.

Relay Name

Pulse/Follow

Set Relay

Reset Relay

Then look at the application page.

Relay 17	Relay 18	Relay 19	Relay 20
Relay 21	Relay 22	Relay 23	Relay 24
Relay 25	Relay 26	Relay 27	Relay 28
Relay 29	Relay 30	Relay 31	Relay 32

Adding a pedestrian crossing to the sequence

In many sequences there are common runs of instructions. Our sequencer allows you to separate out these common sequences and call them from elsewhere in the sequence. Having only a single copy of a sequence aids in maintaining the program. We will expand our traffic light example to demonstrate the call and return instructions, by adding a pedestrian crossing.

We use a digital input for the request to cross button. Before changing our sequence code, we need to provide a latching request signal because pedestrians expect to give the request button a brief push, not hold it down. Lets use relay 22 for the latched request, D1 will set the relay and K7 will clear it.



Relay Name	X Request
Pulse/Follow	0
Set Relay	D1
Reset Relay	K7
Toggle Relay	
Power-up Restore	

Enter D1 in relay 22 Set Relay box and, as the relay will be reset by the sequencer, enter K7 in the Reset Relay box. Also enter K8 and K9 into relay 23 and relay 27 pulse/follow boxes. While we are in the relay section, lets rename the relays to better reflect their functionality.

(21) North RED	(22) X Request	(23) X RED	(24) South RED
(25) North AMBER	.	(27) X GREEN	(28) South AMBER
(29) North GREEN	.	.	(32) South GREEN

Now we can modify the sequencer code. Change the 30 second delays on lines 1 and 5 and replace them with C13. This is a call to line 13, which is on page 2. This will keep the pedestrian routine on one page for easier reading. Also remove all ticks from K1 – K12 on these lines. The Call instruction will ignore them anyway, but it's good to keep things clear.

Page. 1 ▾

Line	Control	K1				K6	K7				K12
01	C13	<input type="checkbox"/>	<input type="checkbox"/>	<input type="checkbox"/>	<input type="checkbox"/>	<input type="checkbox"/>	<input type="checkbox"/>	<input type="checkbox"/>	<input type="checkbox"/>	<input type="checkbox"/>	<input type="checkbox"/>
02	2	<input checked="" type="checkbox"/>	<input checked="" type="checkbox"/>	<input type="checkbox"/>	<input checked="" type="checkbox"/>	<input type="checkbox"/>	<input type="checkbox"/>	<input type="checkbox"/>	<input checked="" type="checkbox"/>	<input type="checkbox"/>	<input type="checkbox"/>
03	60	<input type="checkbox"/>	<input type="checkbox"/>	<input checked="" type="checkbox"/>	<input checked="" type="checkbox"/>	<input type="checkbox"/>	<input type="checkbox"/>	<input type="checkbox"/>	<input checked="" type="checkbox"/>	<input type="checkbox"/>	<input type="checkbox"/>
04	3	<input type="checkbox"/>	<input checked="" type="checkbox"/>	<input type="checkbox"/>	<input checked="" type="checkbox"/>	<input type="checkbox"/>	<input type="checkbox"/>	<input type="checkbox"/>	<input checked="" type="checkbox"/>	<input type="checkbox"/>	<input type="checkbox"/>
05	C13	<input type="checkbox"/>	<input type="checkbox"/>	<input type="checkbox"/>	<input type="checkbox"/>	<input type="checkbox"/>	<input type="checkbox"/>	<input type="checkbox"/>	<input type="checkbox"/>	<input type="checkbox"/>	<input type="checkbox"/>
06	2	<input checked="" type="checkbox"/>	<input type="checkbox"/>	<input type="checkbox"/>	<input checked="" type="checkbox"/>	<input checked="" type="checkbox"/>	<input type="checkbox"/>	<input type="checkbox"/>	<input checked="" type="checkbox"/>	<input type="checkbox"/>	<input type="checkbox"/>
07	60	<input checked="" type="checkbox"/>	<input type="checkbox"/>	<input type="checkbox"/>	<input type="checkbox"/>	<input checked="" type="checkbox"/>	<input type="checkbox"/>	<input type="checkbox"/>	<input checked="" type="checkbox"/>	<input type="checkbox"/>	<input type="checkbox"/>
08	3	<input checked="" type="checkbox"/>	<input type="checkbox"/>	<input type="checkbox"/>	<input type="checkbox"/>	<input checked="" type="checkbox"/>	<input type="checkbox"/>	<input type="checkbox"/>	<input checked="" type="checkbox"/>	<input type="checkbox"/>	<input type="checkbox"/>
09	J1	<input type="checkbox"/>	<input type="checkbox"/>	<input type="checkbox"/>	<input type="checkbox"/>	<input type="checkbox"/>	<input type="checkbox"/>	<input type="checkbox"/>	<input type="checkbox"/>	<input type="checkbox"/>	<input type="checkbox"/>
10		<input type="checkbox"/>	<input type="checkbox"/>	<input type="checkbox"/>	<input type="checkbox"/>	<input type="checkbox"/>	<input type="checkbox"/>	<input type="checkbox"/>	<input type="checkbox"/>	<input type="checkbox"/>	<input type="checkbox"/>

Enter the following on page 2.

Page. 2 ▾

Line	Control	K1				K6	K7				K12
13	30	<input checked="" type="checkbox"/>	<input type="checkbox"/>	<input type="checkbox"/>	<input checked="" type="checkbox"/>	<input type="checkbox"/>	<input type="checkbox"/>	<input checked="" type="checkbox"/>	<input type="checkbox"/>	<input type="checkbox"/>	<input type="checkbox"/>
14	R22, 16	<input type="checkbox"/>	<input type="checkbox"/>	<input type="checkbox"/>	<input type="checkbox"/>	<input type="checkbox"/>	<input type="checkbox"/>	<input type="checkbox"/>	<input type="checkbox"/>	<input type="checkbox"/>	<input type="checkbox"/>
15	X	<input type="checkbox"/>	<input type="checkbox"/>	<input type="checkbox"/>	<input type="checkbox"/>	<input type="checkbox"/>	<input type="checkbox"/>	<input type="checkbox"/>	<input type="checkbox"/>	<input type="checkbox"/>	<input type="checkbox"/>
16	15	<input checked="" type="checkbox"/>	<input type="checkbox"/>	<input type="checkbox"/>	<input checked="" type="checkbox"/>	<input type="checkbox"/>	<input checked="" type="checkbox"/>	<input type="checkbox"/>	<input checked="" type="checkbox"/>	<input type="checkbox"/>	<input type="checkbox"/>
17	5	<input checked="" type="checkbox"/>	<input type="checkbox"/>	<input type="checkbox"/>	<input checked="" type="checkbox"/>	<input type="checkbox"/>	<input type="checkbox"/>	<input checked="" type="checkbox"/>	<input type="checkbox"/>	<input type="checkbox"/>	<input type="checkbox"/>
18	X	<input type="checkbox"/>	<input type="checkbox"/>	<input type="checkbox"/>	<input type="checkbox"/>	<input type="checkbox"/>	<input type="checkbox"/>	<input type="checkbox"/>	<input type="checkbox"/>	<input type="checkbox"/>	<input type="checkbox"/>
19		<input type="checkbox"/>	<input type="checkbox"/>	<input type="checkbox"/>	<input type="checkbox"/>	<input type="checkbox"/>	<input type="checkbox"/>	<input type="checkbox"/>	<input type="checkbox"/>	<input type="checkbox"/>	<input type="checkbox"/>
20		<input type="checkbox"/>	<input type="checkbox"/>	<input type="checkbox"/>	<input type="checkbox"/>	<input type="checkbox"/>	<input type="checkbox"/>	<input type="checkbox"/>	<input type="checkbox"/>	<input type="checkbox"/>	<input type="checkbox"/>

Line 13 is the 30 second delay where we hold all lights at Red. These are the two delays from page 1 lines 1 and 5, where we replaced them with the C13 command. We still need this delay.

Line 14 tests the pedestrian request latch, relay 22, and jumps to line 16 if active, otherwise it continues with line 15 which just return to the caller on page 1.

Line 16 turns the pedestrian signal to Green for 15 seconds and also clears the request signal.

Line 17 returns the pedestrian signal to Red and waits a further 5 seconds for pedestrians to complete the crossing.

Line 18 returns to the main sequence on page 1.

Give it a try!

Schedules

The scheduler can schedule regular events. These can be once or twice daily with the two start and stop times and can happen on any selected weekdays.

dS2832 System Configuration Devantech Ltd

Status
Network
TCP/IP
Relays
Input/Output
dSx Config
Ping
Email
Peer to Peer
Sequencer
Scheduler
Counter/Timer
Application Page

Schedule No.

Target Relay

W/Days S M T W T F S

	Hours	Minutes	Seconds
Start 1	<input type="text" value="6"/>	<input type="text" value="30"/>	<input type="text" value="0"/>
Stop 1	<input type="text" value="7"/>	<input type="text" value="15"/>	<input type="text" value="0"/>
Start 2	<input type="text" value="16"/>	<input type="text" value="30"/>	<input type="text" value="0"/>
Stop 2	<input type="text" value="22"/>	<input type="text" value="45"/>	<input type="text" value="0"/>
Current Time	<input type="text" value="15"/>	<input type="text" value="54"/>	<input type="text" value="8"/>
Time Zone	<input type="text" value="0"/>		
Daylight Saving	<input checked="" type="checkbox"/>		

Scheduler
Schedule daily events with 8 schedules, 2 events per schedule and a week day mask.

The Schedule No. is one of eight schedules that can be set up. These are selected with the Schedule No. box.

The target relay is the local relay that you want this schedule to control.

W/Days selects the days of the week you want this schedule to control the relay. When highlighted in red, the weekday is active.

There are two sets of Start and Stop times for each of the eight schedules. The relay is set when the start time transitions from inactive to active, ie. at the start time, and reset when the stop time is reached. It is not held on or off. It can be changed by other events including the webpage buttons.

The current time originates from an internet time server. It is read only and cannot be changed. Therefore you must have an internet connection for the scheduler to operate correctly.

The timezone allows you to set the time for your location.

For example;
GMT leave this at 0.
CET set this to 1.
PST set this to -8
IST set this to 5:30

Daylight saving time may be checked if required. It advances the time by 1 hour between the last Sunday in March and the last Sunday in October.

As well as controlling a relay directly, schedules may also be used in the boolean equation fields of other controls. A relay could be controlled by placing S1 (for schedule 1) in its automation field.

Counter/Timers

Count input pulses or time events.

The screenshot shows the 'dS2832 System Configuration' web interface. On the left is a vertical menu with buttons for: Status, Network, TCP/IP, Relays, Input/Output, dSx Config, Ping, Email, Peer to Peer, Sequencer, Scheduler, Counter/Timer (highlighted), and Application Page. The main area displays configuration for Counter No. 1. Fields include: Counter Name (Ctr1), Count Input (T1), Capture Input (D3), Reset Input (empty), Current Value (22), and Captured Value (0). A right-hand panel titled 'Counter/Timers' contains explanatory text: 'Eight Counter/Timers. Used as Counters when the count input is connected to an Input. Used as Timers when connected to the internal 1Hz clock, T1. The 32-bit counter counts up from zero to a maximum of 2,147,483,647.' At the bottom right, a status indicator shows a refresh icon and the text 'Update Pending'.

There are a total of eight counter/timers available, selected with the Counter No. box. Each counter can count at a maximum speed of 10Hz (10 counts per second).

Counter Name

Each counter/timer may be named and this name appears on the application page and email notifications.

Count Input

Each counter/timer is capable of being a timer by entering T1 into its count input box. T1 is an internal 1Hz timer that will advance the count once per second. If an input is specified then any pulses on that input will be counted. D4 will count pulses on input 4.

Capture Input

This is the event that will cause the current counter value to be stored in the capture register. The capture register is displayed on the application page, and may also be read using the TCP/IP commands.

Reset Input

This input will reset the counter value to zero. If the capture Input has been left blank then it will store the current counter value in the capture register before resetting it to zero. You may use an input such as D3 or you can use the counter value itself. Entering C1>9 for the counter1 Reset Input will reset the counter when it reaches 10. This will create a repeating 10 step timer (0-9).

Counters, Timers and Schedules can be combined. As an example lets assume we want to count the pulses on input 2. We need to know the number of pules per hour coming in. First we need a 1 hour time base, we'll use counter/timer 1 for this.

Counter No.	1 ▼
Counter Name	Ctr1
Count Input	T1
Capture Input	
Reset Input	C1>3599
Current Value	17
Captured Value	0

Using T1 for the count input will make the counter increment once per second. There are 3600 seconds in 1 hour so we reset the counter when its greater than 3599 with C1>3599. The counter will count from 0-3599.

Next we will use counter 2 to do the counting of input 2 pulses.

Counter No.	2 ▼
Counter Name	Ctr2
Count Input	D2
Capture Input	
Reset Input	C1<1
Current Value	0
Captured Value	0

The count input is set to D2 to count the pulses. The reset input is controlled be counter 1. When it gets reset to zero each hour, so does counter 2. As the capture input is blank the reset event also captures the count value. This may be read any time in the next hour.

The internal time base, T1 is derived from the crystal on the module. It's accurate but will drift over time so that the capture event may not happen "on the hour". Even if you started it on the hour it will drift out by a few seconds a day. So as a final refinement we will synchronize our time base with the real time derived from a schedule.

Schedule No.	1 ▼						
Target Relay	0						
W/Days	S	M	T	W	T	F	S
	Hours	Minutes	Seconds				
Start 1	0	0	0				
Stop 1	0	0	2				
Start 2	0	0	0				
Stop 2	0	0	0				
Current Time	13	3	1				
Time Zone	0						
Daylight Saving	<input type="checkbox"/>						

The target relay is set to zero as we don't need to use any relays for this. All week days are set so we perform the synchronization every day. Start/stop time 1 is used to activate the schedule at 1 second past midnight each day. The second start/stop time is disabled as both times are identical.

Counter No.	1 ▼
Counter Name	Ctr1
Count Input	T1
Capture Input	
Reset Input	C1>3599 S1
Current Value	26
Captured Value	0

Go back to counter1 and add "|S1" to the reset input. Now our time base timer will reset every hour or when schedule1 triggers it.

The application page

The last tab in the configuration pages takes you directly to the application page so you can quickly see the results of your configuration changes.

dScript

YardLights	Relay 2	Relay 3	Relay 4
Relay 5	Relay 6	Relay 7	Relay 8
Relay 9	Relay 10	Relay 11	Relay 12
Relay 13	Relay 14	Relay 15	Relay 16
Relay 17	Relay 18	Relay 19	Relay 20
Relay 21	Relay 22	Relay 23	Relay 24
Relay 25	Relay 26	Relay 27	Relay 28
Relay 29	Relay 30	Relay 31	Relay 32



example.com	<input type="text" value="0"/>	Ctrl1	<input type="text" value="106"/>	<input type="text" value="103"/>
192.168.1.2	<input type="text" value="944"/>	Ctrl2	<input type="text" value="0"/>	<input type="text" value="0"/>
	<input type="text" value="0"/>	Ctrl3	<input type="text" value="0"/>	<input type="text" value="0"/>
	<input type="text" value="0"/>	Ctrl4	<input type="text" value="0"/>	<input type="text" value="0"/>

The I/O indicators show grey when the I/O is inactive. When an active input is applied they show green. Red indicates an active output from the module.

The I/O's are clickable just like the relay buttons to turn them on and off.

The first 4 of the 8 counters are shown, together with their capture registers.

Application page security

The configuration pages (any page name starting with `_config`) are only served when the USB port is connected. If the USB port is unplugged then no configuration pages are served. Instead, you will be served a page saying "You do not have permission to view this page."

The `_pw.htm` page (which contains the javascript that loads the password into your browser) will only be served when the enable `_pw.htm` checkbox is checked on the Webpage Security tab.

If the password field is left blank, the application page will always be served – to anyone! Entering a password means the application page will only be served to a browser that has the matching password set. Everyone else will just be served a simple webpage saying "You do not have permission to view this page."

To summarize, set a password, load it onto your browser, disable `_pw.htm` and un-plug the USB cable. Now you, and only you, can access and control your module.

Accessing your webpage from the internet

Now you have your webpage up and running on your local network, for example 192.168.0.150, and you can access the webpage and control the module. You just go to 192.168.0.150/index.htm, and the page is there.

However you can't get directly at that page from your phone when you are away from home. You can't access it on 192.168.0.150 because your network is not publicly accessible, its a private network address. You will have another IP address. This is the one your ISP gave you for your internet connection, and is the public IP address of your router on the internet. If you don't know what it is you can type "my ip" into Google's search bar and it will tell you. This is the IP address you will use to access the modules webpage.

Everything on the internet uses an IP address and a port number. When you access a webpage in your browser all you enter is the IP address (or more likely a domain name, but its ultimately translated to an IP address). You don't normally have to enter a port number but its still required. Your browser simply uses the default port number, which is 80 for the web, unless otherwise specified our modules also use port 80 for the webpage. However its a good idea to use a different port number for our boards as this will avoid conflict with any web server you may have on your network. Pick a number, I'll choose 19321 as our port number. Just make sure its different from any TCP/IP port number you are using. The HTML port is set on the Webpage Security tab.

After you have re-loaded the program you can access the webpage with:
192.168.0.150:19321/index.htm

Note that as we have changed the modules html port we need to tell the browser how to find the page with the new port number. Do that by inserting a ':' character and the port number between the IP address and the page name as shown above.

Assuming your routers internet IP address is 86.87.88.89 (I made that up – replace with your actual IP address) you will access the page from anywhere with address:
86.87.88.89:19321/index.htm

However first you have to set up your router to do that. It's called "port forwarding" or "virtual server", but whatever your router calls it, you need to set it up so that all incoming connections on port 19321 are forwarded to port 19321 on local IP address 192.168.0.150.

Unfortunately there are so many routers out there we cannot give details on all of them. You should consult your routers manual or search Google for details on your specific router.

Boolean equations

Boolean equations are used in a number of places in the configuration screens. They are used for relay automation, triggering emails and peer to peer events and the count, capture and re-set for the counter/timers.

The types that can be used in boolean equations are:

1. Relays, R1 – R2
2. Digital I/O's, D1 – D4
3. Analog inputs, A1 – A2
4. Pings P1 - P4
5. Sequencer, K1 - K12
6. Schedules, S1 – S8
7. Counters, C1 – C8
8. 1Hz Time base, T1

The simplest equation is R1. This is true when R1 is active and not true when R1 is in-active. If you enter R1 in the relay 2 automation box it will simply follow whatever R1 does.

The exclamation mark ! is used as a "not". So !R1 is true when relay 1 is in-active. Enter !R1 in the relay 2 automation box it will follow the opposite of R1. Relay 2 will be active when relay 1 is inactive.

The same applies to the digital I/O's. Enter D2 in the relay 2 automation box and the relay will follow the input.

Analog inputs and Counter values are compared with a number to obtain a true/false boolean result. In this example we will use analogue input 1. Then we can enter $A1 < 1000$ in the relay2 automation box. This will turn on relay 2 when the input A1 falls below 1000. If A1 is connected to a temperature sensor and R2 controls a heater – well, you get the idea. Analog comparisons use the "less than" < and "greater than" > symbols only. There is no equal or not equal. Checking for equality on a potentially jittery analogue input is not really useful.

As well as "not" !, you can use "and" & and "or" | in your equations. Enter $D2 \& D3$ and the result is true only when both D2 and D3 are active. Enter $D2 | D3$ and the result is true when either D2 or D3 is active.

What happens here:

$D2 | D3 \& D4$

The answer is that boolean expressions are evaluated left to right. So D2 is ORed with D3 and the result ANDed with D4. You can change the order of precedence by using parenthesis ().

$D2 | (D3 \& D4)$

will now AND D3 with D4 and the result is Ored with D2.

To demonstrate a real world example, take the analog example above where we compared A1 with 1000 to operate R2. Whilst this would work its a not a good solution as the relay would jitter badly when A1 was hovering between 999 and 1000. What we need is some hysteresis. To do that we will use R2 in its own equation.

$(A1 < 1000 \& !R2) | (A1 < 1234 \& R2)$

Assume R2 is inactive (off). The 2nd half of the equation $(A1 < 1234 \& R2)$ will have no effect.

So when A1 falls below 1000 the relay comes on. Now the 2nd half of the equation is true, and will stay true until A1 climbs above 1234.

So the relay becomes active when A1 is below 1000 and inactive above 1234.

We have hysteresis!

TCP/IP command sets

There are four TCP/IP command sets on four selectable check boxes, of which one or none may be selected on the TCP/IP config tab. These are ASCII, Modbus, Binary and Binary with AES256 encryption.

ASCII command set

The ASCII command set allows you to type commands using a TCP/IP terminal program such as PuTTY. Use PuTTY in raw mode.

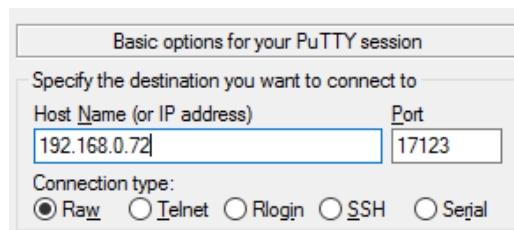

Make sure you have you module set to ASCII mode and, after the "update Pending" indicator has gone out, re-booted the module so the changes take effect.

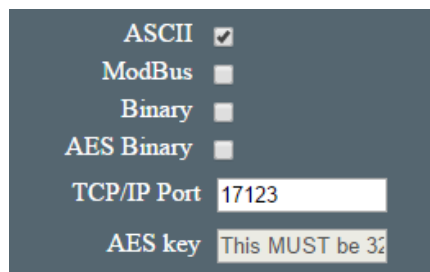

ASCII commands are all two character commands and are not case sensitive. Type ST followed by the return key. This is the STatus command. You will see:

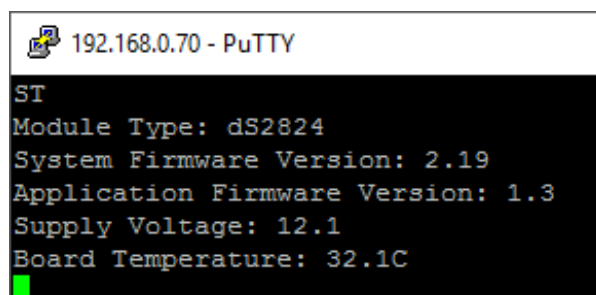

Valid commands are:

ST SStatus request

SR [Relay number] [on/off] {Pulse time in mS}

SR 1 on Set Relay 1 on

SR 1 off Set Relay 1 off

SR 1 on 1000 Set Relay 1 on for 1 second

SO [Output number] [on/off]

SO 1 on Set Output 1 on

SO 1 off Set Output 1 off

GR [Relay number]

GR 1 Get relay 1 status – responds with Active or Inactive

GI [Input number]

GI 1 Get Input 1 status – responds with Active or Inactive

GA [Analog Input number]

GA 1 Get Analog input 1 – responds with the 12-bit analog value

GC [Counter Number]

GC 1 Get Counter 1 – responds with count, capture values.

Note – on the dS2832, GI and GA are identical, getting the digital state or analogue value depending on the port configuration in the I/O Types tab.

Typical PuTTY session.

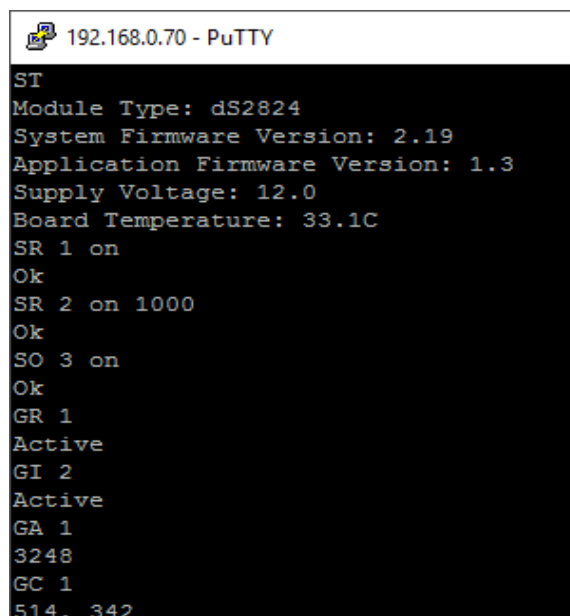

```
192.168.0.70 - PuTTY
ST
Module Type: dS2824
System Firmware Version: 2.19
Application Firmware Version: 1.3
Supply Voltage: 12.0
Board Temperature: 33.1C
SR 1 on
Ok
SR 2 on 1000
Ok
SO 3 on
Ok
GR 1
Active
GI 2
Active
GA 1
3248
GC 1
514, 342
```

Binary command set

Summary.

0x30 Get Status
0x31 Set relay
0x32 Set output
0x33 Get Relays
0x34 Get Inputs
0x35 Get Analogue
0x36 Get Counters
0x37 Update all Relays

0x30 (decimal 48) Get Status (1 byte command, returning 8 bytes)

This command returns 8 bytes of status data

Module ID	This will be 42 (0x2A) for the dS2832
System Firmware Major	2 for example
System Firmware Minor	18 for example
Application Firmware Major	1 for example
Application Firmware Minor	2 for example
Volts	Power supply volts x 10. Example 125 is 12.5v
Internal Temperature (high byte)	x 10
Internal Temperature (low byte)	combined to 16 bits, 267 = 26.7 degrees C

In the above example the returned bytes would be:

0x22 0x02 0x12 0x01 0x02 0x7D 0x01 0x0B

The last two bytes combined are 0x10B which is 267 decimal.

0x31 0x02 0x01 0x00 0x00 0x00 0x00 Set Relay (7 byte command, returning 1 byte)

This command turns a relay on or off or pulses it for a time period and returns an ACK/NACK byte. ACK=0, NACK=non-zero (actually the unknown relay number).

0x31 The actual command, the rest are parameters.

0x02 Relay number. Valid numbers are 1-32 (0x01-0x20)

0x01 Turn relay on (0x00 for off). This is ignored when following pulse time is >100.

0x00 } high byte Pulse time

0x00 } mid high These 4 bytes combined are a 32-bit pulse time for the relay

0x00 } mid low when less than 100 (as it is here 0x00000000) its ignored

0x00 } low byte When >100 this pulses relay on for that number of mS

To pulse relay 5 on for one second the command is:

0x31 0x05 0x00 0x00 0x00 0x03 0xE8

0x000003E8 (or just 0x3E8) is 1000 decimal, which is 1000mS or 1 second.

The relay will turn on and then go off 1 second later.

When sending a relay pulse time, the relay on/off byte is ignored. The relay is always on for the duration of the pulse.

Binary Command Set – continued.

0x32 0x04 0x01 Set Output (3 byte command, returning 1 byte)

This command turns an output on or off and returns an ACK/NACK byte. ACK=0, NACK=non-zero (actually the unknown I/O port number).

All I/O's which need to be inputs should have the output turned off. When turned on the NPN transistor can sink up to 100mA.

0x32 The command, the rest are parameters

0x04 the I/O number, 4 in this case.

0x01 on (0x01) or off (0x00)

0x33 0x01 Get Relay (2 byte command – returning 5 bytes)

This command is used to get the states of the relays. The second byte is the relay number, relay 1 in this case.

The first returned byte is the state of the requested relay, 0x00 (off) or 0x01 (on).

The next four bytes pack the states of all 32 relays. Bit 7 of byte 2 is relay 32 through to bit 0 of byte 5 which is relay 1.

Byte 2								Byte 3								Byte 4								Byte 5							
7	6	5	4	3	2	1	0	7	6	5	4	3	2	1	0	7	6	5	4	3	2	1	0	7	6	5	4	3	2	1	0
32	31	30	29	28	27	26	25	24	23	22	21	20	19	18	17	16	15	14	13	12	11	10	9	8	7	6	5	4	3	2	1

If the bit is set the relay is on, off otherwise.

0x34 0x01 Get Input (2 byte command – returning 2 bytes)

This command is used to get the states of the inputs. The second byte is the input number, input 1 in this case.

The first returned byte is the state of the requested input, 0x00 (inactive) or 0x01 (active)

the second byte packs the states of all 8 inputs. Bit 7 is input 8 through to bit 0 which is input 1. If the bit is high the input is active.

	Byte 2							
Bit No.	7	6	5	4	3	2	1	0
Input	8	7	6	5	4	3	2	1

0x35 Get Analogue inputs (1 byte command returning 16 bytes)

This returns all eight possible analogue inputs. 16 bytes are returned, 2 for each analogue input.

Byte 1 byte 2 for example:
0x02 0x3E combined to 0x023E, or 574 decimal for input 1.

Byte 3 byte 4 combined to 0x01FB, or 507 decimal for input 2.

Bytes 5 – 14 follow in a similar way.

Byte 15 byte 16 combined to 0x032C, or 812 decimal for input 8.

If the input is configured as a digital port then the input will be 0 or 1.

0x36 0x01 Get Counters (2 byte command – returning 8 bytes)

This command is used to get the counters. The second byte is the counter number, counter 1 in this case.

The first 4 bytes returned is the current counter value. This 32-bit (4 bytes) value is returned high byte first. The second group of 4 bytes returned is the capture register for this counter, also a 32-bit (4 byte) value returned high byte first.

0x37 0xnn 0xnn 0xnn 0xnn Update all relays (5 byte command returning 1 byte)

This command is used to update all relays with one command returning an ACK/NACK byte. ACK=0, NACK=non-zero. If a bit is high (1), the corresponding relay will be turned on. If a bit is low (0) the corresponding relay will be turned off. This command therefore affects all relays. The bit order is the same as the Get Relay command.

Byte 2								Byte 3								Byte 4								Byte 5							
7	6	5	4	3	2	1	0	7	6	5	4	3	2	1	0	7	6	5	4	3	2	1	0	7	6	5	4	3	2	1	0
32	31	30	29	28	27	26	25	24	23	22	21	20	19	18	17	16	15	14	13	12	11	10	9	8	7	6	5	4	3	2	1

0x38 0xnn 0xnn 0xnn 0xnn Set selected relays (5 byte command returning 1 byte)

Set only those relays with a corresponding high in the bit pattern returning an ACK/NACK byte. ACK=0, NACK=non-zero. Same bit order as command 0x37 above.

Relays with a corresponding low (0) are NOT affected and remain on/off as previously set.

0x39 0xnn 0xnn 0xnn 0xnn Clear selected relays (5 byte command returning 1 byte)

Clears only those relays with a corresponding high in the bit pattern returning an ACK/NACK byte. ACK=0, NACK=non-zero. Same bit order as command 0x37 above.

Relays with a corresponding low (0) are NOT affected and remain on/off as previously set.

AES binary command set

The AES Binary commands are the same as the Binary commands described above. The only difference is that they are AES encrypted and always 16 bytes in length. The first bytes are the same as described in the Binary command set. The last 4 bytes is the Nonce (a random number) and the bytes in the middle are undefined. The module will decrypt the command, generate the response and encrypt it before returning it to you.

Your program that controls the module will need to encrypt the commands and then decrypt the response.

We use AES256 CBC encryption, hence the requirement for a 256 bit (or 32 byte) key. To complete the security we use a random IV generated by a cryptographically secure random number generator (ISAAC).

To control the module you will need to send the commands with AES encryption. To help you with this we have examples in C#, Java and Python. The C# and Java applications are complete and may be used or modified as you wish.

To prevent re-play (or Playback) attacks the command packet includes a Nonce. This takes the form of a 32-bit (4 byte) random number in positions 12, 13, 14 & 15 of the 16 byte data packet. For example when you send a Get Status command (0x30) you will get a 16 byte block returned. The first 8 bytes (0-7) will be as defined for the binary commands. Bytes 8-11 are unused. Bytes 12-15 contain the Nounce.

Commands with generate and send you a Nounce are:

- 0x30 – Get Status
- 0x31 – Set Relay
- 0x32 – Set Output
- 0x37 – Update all relays, On or Off
- 0x38 – Set only relays with corresponding bit set to On
- 0x39 – Clear only relays with corresponding bit set to Off

Commands which require a Nounce to be sent by you are:

- 0x31 – Set Relay
- 0x32 – Set Output
- 0x37 – Update all relays, On or Off
- 0x38 – Set only relays with corresponding bit set to On
- 0x39 – Clear only relays with corresponding bit set to Off

A Nounce is only ever used once, you must always used the most recently issued Nounce.

The following example shows how the Nounce provided by the module is used in the next Set Relay or Set Output command.

	0	1	2	3	4	5	6	7	8	9	10	11	12	13	14	15
Get Status	0x30	xx	xx	xx	xx	xx	xx	xx	xx	xx	xx	xx	xx	xx	xx	xx
Response	0x22	0x02	0x12	0x01	0x02	0x7D	0x01	0x0B	xx	xx	xx	xx	0x89	0xAB	0xCD	0xEF
Set Relay	0x31	0x02	0x01	0x00	0x00	0x00	0x00	xx	xx	xx	xx	xx	0x89	0xAB	0xCD	0xEF
Response	0x00	xx	xx	xx	xx	xx	xx	xx	xx	xx	xx	xx	0x1A	0x2B	0x3C	0x4D
Set Relay	0x31	0x03	0x01	0x00	0x00	0x00	0x00	xx	xx	xx	xx	xx	0x1A	0x2B	0x3C	0x4D
Response	0x00	xx	xx	xx	xx	xx	xx	xx	xx	xx	xx	xx	0xF1	0xE2	0xD3	0xC4
Set Output	0x32	0x04	0x01	xx	xx	xx	xx	xx	xx	xx	xx	xx	0xF1	0xE2	0xD3	0xC4
Response	0x00	xx	xx	xx	xx	xx	xx	xx	xx	xx	xx	xx	0x5C	0x47	0x9B	0xED

If the Nounce you send with the command does not match the last one sent to you, then the Relay (or Output) will not be changed.

No other commands either require or provide a Nounce.

Modbus commands

The modbus command set accepts a subset of the standard Modbus-TCP frames as defined in [Modbus protocol Specification](#) and [MODBUS Messaging on TCP/IP Implementation Guide V1.0b](#)

Functions 1, 4, 5 & 15 are supported along with error codes 1, 2 & 3 should they occur.

Function 01 (0x01) Read Coils

This function reads back the 32 relays as coils 1-32, and the 8 I/O's as coils 41-48.

Function 04 (0x04) Read Input Registers

This function reads back the 8 analogue inputs (if configured as analogue inputs) as registers 1-8

Registers 9-24 are 16 registers representing 8 counter values. As modbus registers are 16-bits wide and the counters are 32-bit, a counter is stored in 2 16-bit registers, high word first. In the same way, the 16 registers 25-40 hold the 8 capture values.

Register 9	Counter1 high word	Register 25	Capture1 high word
Register 10	Counter1 low word	Register 26	Capture1 low word
Register 11	Counter2 high word	Register 27	Capture2 high word
Register 12	Counter2 low word	Register 28	Capture2 low word
Register 13	Counter3 high word	Register 29	Capture3 high word
Register 14	Counter3 low word	Register 30	Capture3 low word
Register 15	Counter4 high word	Register 31	Capture4 high word
Register 16	Counter4 low word	Register 32	Capture4 low word
Register 17	Counter5 high word	Register 33	Capture5 high word
Register 18	Counter5 low word	Register 34	Capture5 low word
Register 19	Counter6 high word	Register 35	Capture6 high word
Register 20	Counter6 low word	Register 36	Capture6 low word
Register 21	Counter7 high word	Register 37	Capture7 high word
Register 22	Counter7 low word	Register 38	Capture7 low word
Register 23	Counter8 high word	Register 38	Capture8 high word
Register 24	Counter8 low word	Register 40	Capture8 low word

Function 05 (0x05) Write Single Coil

This function is used to write to a single coil (relay or I/O). Coils 1-32 are the relays 1-32. I/O's 1-8 are remapped to coils 41-48.

Function 15 (0x0F) Write Multiple Coils

Use this function when you need to write to multiple relays and I/O's at the same time. Coils 1-32 are the relays 1-32. Coils 41-48 are the I/O's 1-8 remapped to 41-47.

Error code 1

This error is returned if an unknown or unimplemented function is received. Only functions 1, 4 & 5 are implemented.

Error code 2

This error is returned if an illegal address is requested. Addresses greater than 32 for functions 1 & 5 or greater than 8 for function 4 will generate this error.

Error code 3

This error is returned if an illegal data value is received. Number of points = zero will generate this as will an illegal data value for function 5.

Modbus Gateway

If the Modbus/TCP/IP frame has a UID that does not match the one you set in the TCP/IP config screen, the module will assume this is for another Modbus module connected to the RS485 port. It will use the UID as the Module address, convert the request to RTU format and send it to the downstream module. This could be an MBH88 for example. The return frame is then converted back to Modbus/TCP/IP format and returned to you.

Make sure you set the Parity and Baud Rate in the TCP/IP config screen to match your Modbus RTU modules.

Loading the application firmware

If your module does not flash the blue LED three times on power-up, you will need to update the system firmware and load the application program. These instructions should also be followed if you want to update your firmware to the latest version or even revert to an earlier version.

You need to download the dScript programming environment from here:
<http://www.robot-electronics.co.uk/dscript.html>

PC requirements

Windows 7 or later, Linux or MAC OS X
USB port to program the module.

The dScript IDE is supplied as a zip file that can be download and unzipped into a temporary folder, inside the temporary folder will be four folders:

Installation
USBdriver
Examples
Documentation

Go to the Installation directory and click "setup" to install the dScript IDE, if you have already installed a previous version you will need to uninstall it before installing the new one.

The USBdriver folder contains the USB com port driver for the modules.

Copy the Examples directory to a convenient location on your computer, it contains both dScript source code examples and associated web pages, one of which is the application firmware you will need.

In this order:

1. Start from this position:
 - a. dScript Editor closed down.
 - b. dS2832 not connected or powered.
2. Power-up the dS2832.
3. Hold down the reset button for a couple of seconds until the red LED comes on. This indicates the module is in boot-loader mode.
4. Connect the USB lead to the PC. If windows wants a driver, point it to the USB driver folder and install the driver from there.

5. Run the dScript editor. Look in Help→About and check you have the latest version of dScript. In this case 4.10

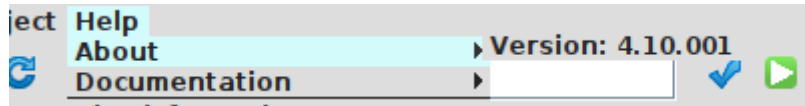

If you have an earlier version you should uninstall it and install the new version from the installation folder, then start these instructions from the beginning. Older versions will not work with the new application.

6. Now look in the Module panel, you should see:

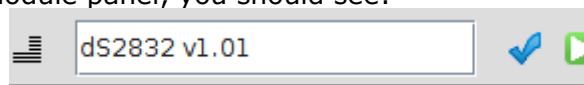

v1.01 indicates it's the boot-loader that is running.

7. Load the project: File→Open project
\\dScriptPublish-4-10\Examples\app-dS2832-v4-10\app-dS2832-v4-10.dsj
8. Click the build button (white triangle on green button). This will update the system firmware and load the application.
9. When done, the new version will be displayed:



Erasing old configuration settings

Uploading the firmware, as described in the previous section, will not erase all the configuration values. If you need to clear these, do the following:

Load up the app-dS2832-v4-10 application in the editor, but before you upload it to the dS2832 you need to make a small change. Locate the thread "main" (click the word in the right panel is quickest). Just below this is a commented out line "init()".

```
2799      threadsleep 10
2800      loop
2801  endthread
2802
2803 thread main(const)
2804     if initControl != AppVersion Init()           ; init module if different from app version
2805     ; Init()                                     ; uncomment this line to force init
2806
2807     if System_RLY_PUR&0x00000001 Rly1 = RelayStore[0]           ; restore relay states on power up
2808     if System_RLY_PUR&0x00000002 Rly2 = RelayStore[1]
2809     if System_RLY_PUR&0x00000004 Rly3 = RelayStore[2]
2810     if System_RLY_PUR&0x00000008 Rly4 = RelayStore[3]
2811     if System_RLY_PUR&0x00000010 Rly5 = RelayStore[4]

```

```
Binary()
CalcVoltsTemp(1000)
DoBinary()
DST(UseDST)
generateEmailMsg()
GetAttachedRly()
GetNonce()
Init()
main(const)
ModBus()
ModBus_ReadCoils()

```

Uncomment this by removing the semicolon.

```
2799      threadsleep 10
2800      loop
2801  endthread
2802
2803 thread main(const)
2804     if initControl != AppVersion Init()           ; init module if different from app version
2805     Init()                                     ; uncomment this line to force init
2806
2807     if System_RLY_PUR&0x00000001 Rly1 = RelayStore[0]           ; restore relay states on power up
2808     if System_RLY_PUR&0x00000002 Rly2 = RelayStore[1]
2809     if System_RLY_PUR&0x00000004 Rly3 = RelayStore[2]
2810     if System_RLY_PUR&0x00000008 Rly4 = RelayStore[3]
2811     if System_RLY_PUR&0x00000010 Rly5 = RelayStore[4]

```

```
Binary()
CalcVoltsTemp(1000)
DoBinary()
DST(UseDST)
generateEmailMsg()
GetAttachedRly()
GetNonce()
Init()
main(const)
ModBus()
ModBus_ReadCoils()

```

Now upload the application and it will reset the IP address along with all other variables. Confirm the board is operating, but don't change anything yet.

You need to replace the semicolon and upload the application again, otherwise it will continue to reset everything each time you power-up.

A faster method is to load the supplied Blank.dsf configuration file from the Examples folder.

dS2832 hardware

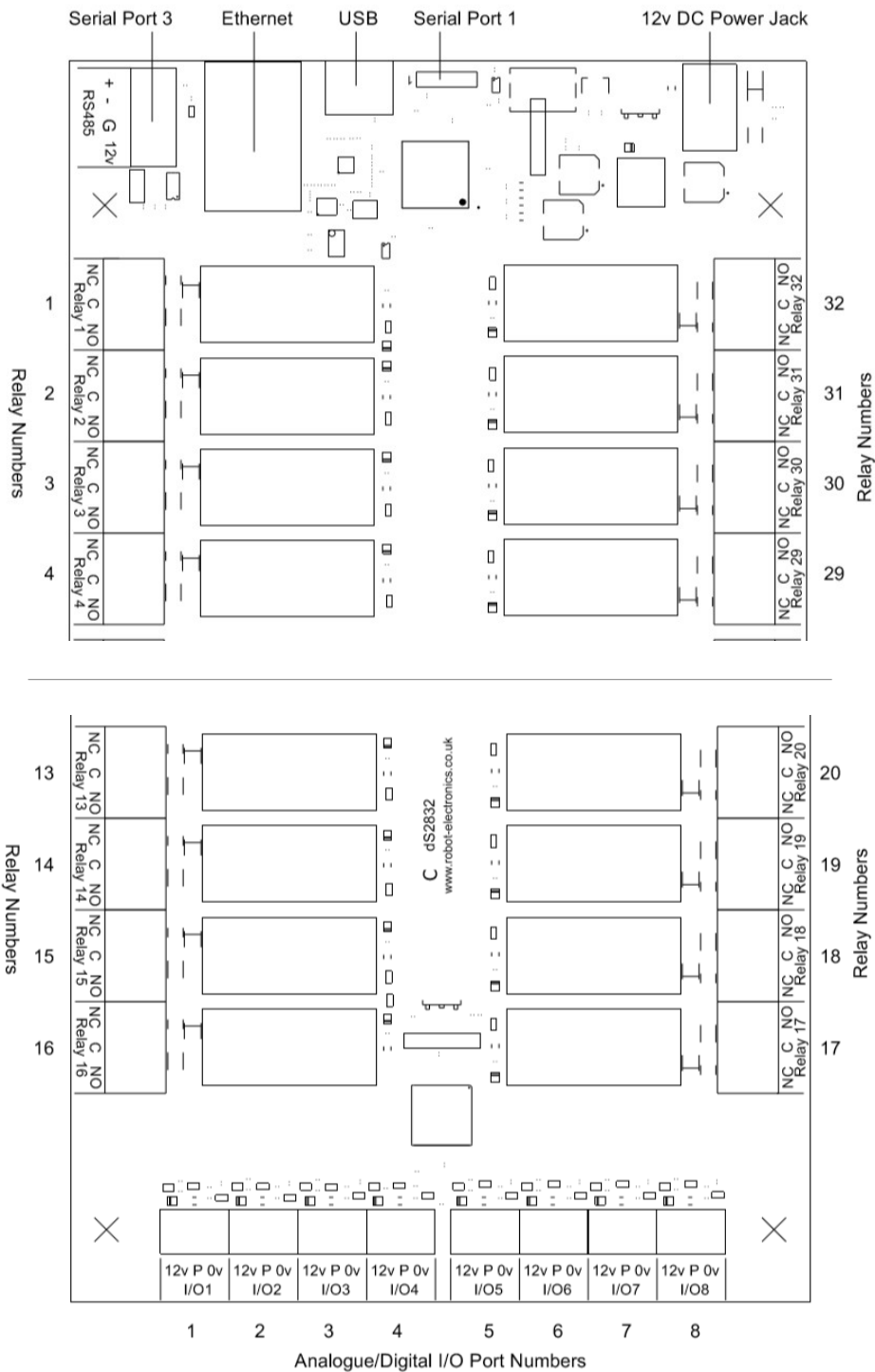

The dS2832 provides 32 volt free contact relay outputs with a current rating of up to 16Amp each, 8 flexible I/O's which can be analogue or digital and 1 serial port (3.3v level). The module is powered from a 12vdc supply which can be regulated or unregulated. The relays are SPCO (Single Pole Change Over) types. The normally open, normally closed and common pins are all available on the screw terminals.

LED indication

The dS2832 provides a red LED mounted immediately next to each relay to indicate whether it is in a powered state (LED on), there are also two LED's mounted in the Ethernet connector which will flash with Ethernet traffic. A row of three LEDs, Blue, Green and Red, are available for status indication. The Red LED lights when the module is in bootloader mode – this is when the IDE is uploading system firmware to the module. The Green LED lights the board begins running user programs. All three LEDs are available and can be controlled as digitalports 33-35.

<code>digitalport</code>	LedBlue	33
<code>digitalport</code>	LedGreen	34
<code>digitalport</code>	LedRed	35

The "FlashingLeds" example provides a colourful display showing how to use them.

There are also LEDs on the I/O lines. These indicate the I/O status in digital output and VFC input modes only.

Power supply

The dS2832 requires a 12v DC supply capable of supplying a minimum of 2A. This is most easily provided by a low cost mains adapter. A suitable universal adapter is available on our website and may be ordered along with the modules. Connection is via the 2.1mm DC jack socket. Positive on the center pin.

Operating temperature

-40C to +70C

Power relays

Four 16A volt free contact relays are provided for switching a common input between a normally closed output and a normally open output. The relay coil is powered by the 12vdc incoming supply on user command.

Relay in passive state

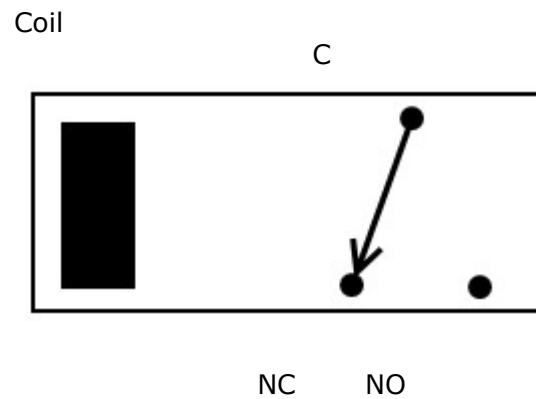

Relay in powered state

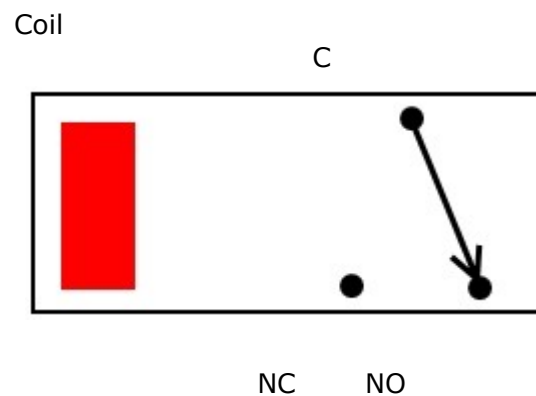

A full datasheet for the relays used on the dS2832 is here: [HF115FD datasheet](#)

Analogue/Digital flexible I/O's

The dS2832 has eight flexible I/O ports, numbered 1-8, which can be your selection of:

1. Digital open collector output.
2. Digital open collector output with passive pullup to 12v
3. Digital input (0-12v, 2.5v threshold).
4. VFC (Volt Free Contact) input.
5. 12-bit Analogue input, range 0-4.096v or 0-5v.

Connection examples

Example input - connecting a switch

Connecting a simple switch could not be easier, just wire the switch between a pin (P) and ground (0v). When the switch closes the input will become active.

Make sure you use the 1 option in the digital-port declaration to enable the ports passive pull-up

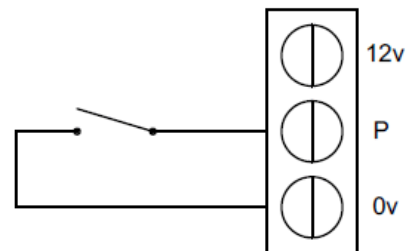

Example output - connect a relay

You can connect your own 12V relays, the first coil pin of the relay is wired to the 12V supply terminals on the board, the other is wired to the output pin (P). When the output pin becomes active it is driven down to 0V ground, the relay will have 12V across the terminals and switch, so COM is connected to NO (Normally Open).

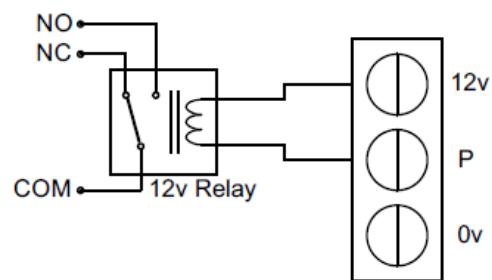

Temperature sensor

There is an on-board temperature sensor (MCP9700A) which provides a 10mV/°C output on a 500mV offset (0°C = 500mV, 1°C = 510mV). This is accessed as analogue channel 100. The sensor is located between the Ethernet and RS485 connectors.

```
analogport  TS1          100    ; on-board temp sensor
int32       BrdTemp
BrdTemp = ((TS1*3223)-500000)/10000
```

This will give you the approximate temperature in °C.

Power supply input voltage

A simple resistive divider on analogue channel 101 is used to measure the 12v input voltage.

```
analogport  PSU          101    ; DC power voltage
int32       Volts
Volts = PSU*18369/100000    ; calc input voltage.
```

This will give you volts*10. So 119 = 11.9v, 120 is 12.0v

Analogue channels

100 Temperature
101 Voltage

Channels 1–8 are Flexport channels, 12-bit resolution using 5v from regulator as reference.
Channels 100,101 are 10-bit resolution, using CPU 3.3v supply as reference.

Representative flexible I/O schematic

P1 controls the passive pull-up. It is automatically disabled in analogue modes and set by the option in the digitalport declaration in digital modes.

Q1 controls the open collector NPN output. It is set by writing to the port.

D1 is the ports input. It supplies the 12bit ADC in analogue modes and is read as 0 or 1 in digital modes.

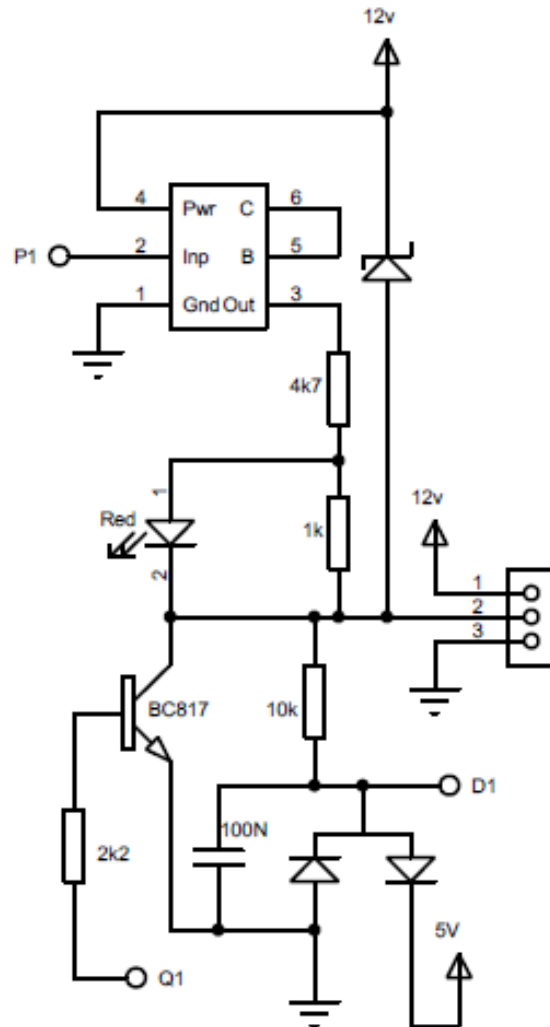

Serial port connections

TTL serial port.

The dS2832 has one serial port header which is serial port 1 in dScript. Pin 1 is marked on the PCB.

Tx and Rx operates at 3.3v levels, however the Rx input is 5v tolerant. Most 5v TTL level serial ports will accept a full 3.3v input ensuring the port is compatible with most 5v devices such as the LCD05 display modules. That is the reason 5v (rather than 3.3v) is available on pin1 to power external modules.

The 5v supply can source up to 200mA. Keep the leads short and away from high voltages.

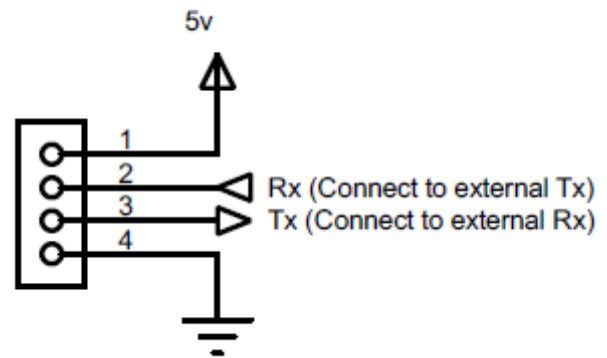

RS485 serial port.

Referred to as serial port 3 in dScript.

The 12v power is not part of the RS485 specification, it is there to provide convenient power for any 12v sensors you may wish to connect such as our SRF485 ultrasonic rangers.

Connections for the RS485 port are also clearly labeled on the PCB.

The two pin link near to the RS485 terminal block should be shorted to use the on-board 120 ohm terminating resistor.

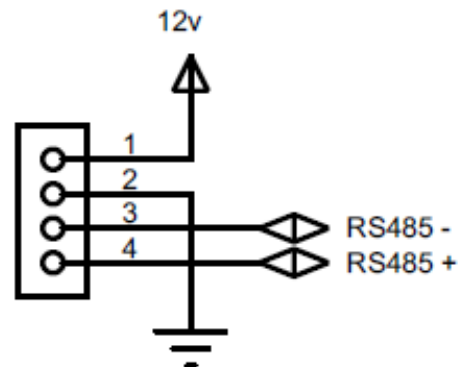

Notes.

1. Serial port 2 is not available on the dS2832.
2. Serial ports are available when programming in dScript

dS2832 dimensions

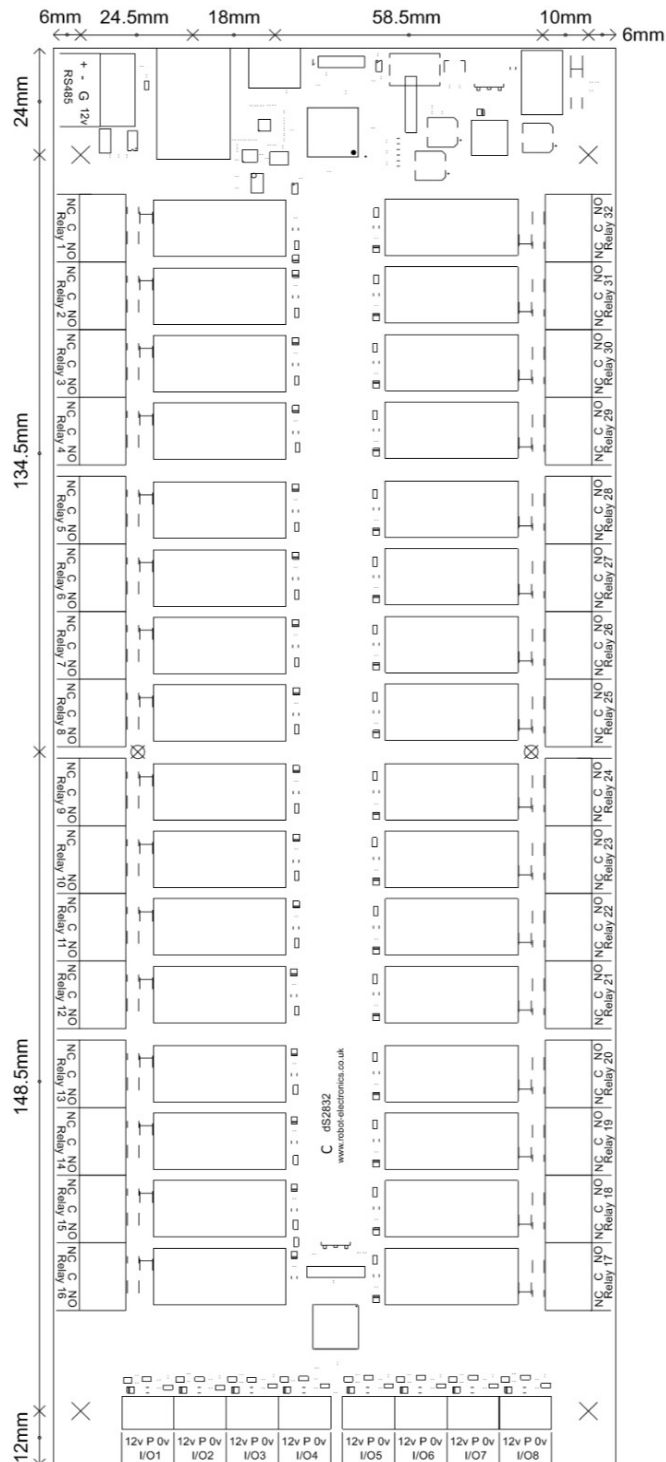

Notes